



Fondata nel 1997 a Sabbio Chiese, in provincia di Brescia, Arieni nasce dall'esperienza e dal know-how tecnico maturati dai soci fondatori e dalla volontà di proporre al mercato un catalogo ampio e assortito di maniglie e accessori belli e durevoli, con un ottimo rapporto qualità-prezzo, sviluppati per soddisfare differenti gusti ed esigenze architettoniche. Oggi Arieni è un'azienda a conduzione familiare solida e dinamica, guidata dall'esperienza maturata in oltre vent'anni di attività nel settore e dalla spinta innovativa del suo giovane management. Flessibilità, modernità, competenza e professionalità si fondono in questa realtà, nota a livello internazionale per la qualità costruttiva e la competitività delle sue collezioni. Oltre ad una scelta estremamente ampia di modelli, accessori e guarnizioni che ben soddisfano le più diverse esigenze, Arieni si contraddistingue per il suo servizio puntuale e altamente specializzato, che si traduce in una costante attività di assistenza al cliente. Dalla rapidità di preventivi e consegne fino al continuo supporto nella fase di scelta dei prodotti più indicati per ogni situazione e alla consulenza tecnica per l'installazione finale, Arieni è un punto di riferimento professionale, attento e affidabile, sempre a disposizione per garantire il miglior risultato finale. La costante attenzione al cliente, inoltre, permette all'azienda di operare un continuo processo di miglioramento e innovazione, che si riflette in proposte sempre in linea con le ultime tendenze.

Established in 1997 in Sabbio Chiese, in the Italian province of Brescia, Arieni originates from the experience and technical know-how of its founding shareholders and on their will to offer the market a full and a varied catalogue of beautiful and long-lasting handles and accessories, having an excellent quality-price ratio, developed to satisfy different architectural tastes and requirements. Today Arieni is a solid and dynamic family-run company led by experience gained in over 20 years of business in the industry field and by the innovative motivation of its young management. Flexibility, modernity, expertise and professional competence merge together in this company renowned at the international level for its quality and the competitiveness of its collections. In addition to an extremely vast selection of styles, accessories and gaskets that fully meet many different requirements, Arieni distinguishes itself also for the prompt and highly specialised service, that is its steady customer assistance. From the prompt reply to enquiries and deliveries up to the non-stop support when selecting the most recommended products for every situation and to the technical consulting for their final installation, Arieni is a professional, accurate and reliable company, always available to guarantee the best end results. Its constant attention paid to customers also allows the company to perform a constant improvement and innovation process that is reflected in items always in line with the latest trends.



PAGINA PAGE		PAGINA PAGE		PAGINA PAGE	
8-105	CONTEMPORARY	110-125	BASIC	166-173	INOX
106-109	MINIMAL	126-165	COORDINATI	174-201	ATELIER

CONTEMPORARY

PAGINA PAGE			PAGINA PAGE		
8-9	VERA		30-31	LASER	
10-11	CHIC		32-33	QUASAR	
12-13	NIKO		34-35	PIPITA	
14-15	ARES		36-37	QUADRA	
16-17	RING		38-39	BOEMIA	
18-19	AREA 51		40-41	QUADRA SPORT	
20-21	DEA		42-43	BELLA	
22-23	Q-CINQUE		44-45	CITY	
24-25	SIRIO		46-47	YORK	
26-27	B-52		48-49	DUNA	
28-29	PIEGO		50-51	GAIA	

PAGINA PAGE			PAGINA PAGE		
52-53	OPERA		80-81	SPIRIT	
54-55	MODERNA		82-83	MIZAR	
56-57	PEGASO		84-85	ALTAIR	
58-59	SMART		86-87	SOLE	
60-61	PRIMA		88-89	OMEGA	
62-63	FORTUNA		90-91	MIRADUE	
64-65	ONDA		92-93	GRETA	
66-67	CASTEL		94-95	JOLLY	
68-69	VENUS		96-97	DOLLY	
70-71	MAREA		98-99	POLAR	
72-73	PRESSBURG		100-101	ARCA	
74-75	CLASSIC		102-103	CIGNO	
76-77	LIBERTY		104-105	SCILLA	
78-79	MERAK				















MINIMAL

PAGINA PAGE			PAGINA PAGE		
106	SLIM		108	PIC MINI	
107	YORK MINI		109	PRIMA MINI	

BASIC

PAGINA PAGE			PAGINA PAGE		
111	ISCHIA		119	CASTOR	
112	PONZA		120	MIRA OTT.	
113	CAPRI		121	MIRA ZAMA	
114	S-QUADRA		122	ALCOR	
115	SPORT-ALL		123	THEMA	
116	SMART ECO		124	KARIZ	
117	COMPATTA		125	ATRIA	
118	MIZAR ECO				

COORDINATI

PAGINA PAGE		PAGINA PAGE	
126-131	MANIGLIONI	152-155	KIT HOTEL
			
133-134	COPPIA POMOLI	156	COPRIAVVOLGITORI E BUCALETTERE
			
135-136	POMOLI SINGOLI FISSI		
			
138-139	CHIAVISTELLI PER TOILETTE	157	BATTENTI
			
140-147	KIT PER SCORREVOLI	158-159	ARTICOLI PER BLINDATI
			
148-150	ACCESSORI PER SCORREVOLI	160	LIMITATORI DI APERTURA
			
151	ALZANTI PER SCORREVOLI	161	SEGRETINI E SPIONCINI
			
		162-165	ACCESSORI
			

INOX

PAGINA PAGE			PAGINA PAGE		
167	AMBRA		169	GIRO	
167	BIG LEVA		169	ORION	
168	CORNER		170-171	MANIGLIONI	
168	APUS				

ATELIER

PAGINA PAGE			PAGINA PAGE		
178-179	STILE		186-187	RUSTICA	
180-181	TOSCANA		188-189	EPOCA	
182-183	REGINA		190-191	PRESSBURG	
184-185	ANTIQUA		192-193	LUXOR	
194-195	MANIGLIONI		198-199	KIT SCORREVOLI E MINUTERIA	
196-197	POMOLI BATTENTI E ALZANTI		200-201	COMPONENTI	

PAGINA PAGE	CODICE CODE	SERIE SERIES	PAGINA PAGE	CODICE CODE	SERIE SERIES
84-85	ALTAIR	CONTEMPORARY	118	MIZAR ECO	BASIC
167	AMBRA	INOX	54-55	MODERNA	CONTEMPORARY
184-185	ANTIQUA	ATELIER	12-13	NIKO	CONTEMPORARY
168	APUS	INOX	88-89	OMEGA	CONTEMPORARY
100-101	ARCA	CONTEMPORARY	64-65	ONDA	CONTEMPORARY
18-19	AREA 51	CONTEMPORARY	52-53	OPERA	CONTEMPORARY
14-15	ARES	CONTEMPORARY	169	ORION	INOX
125	ATRIA	BASIC	56-57	PEGASO	CONTEMPORARY
26-27	B - 52	CONTEMPORARY	108	PIC MINI	MINIMAL
42-43	BELLA	CONTEMPORARY	28-29	PIEGO	CONTEMPORARY
167	BIG LEVA	INOX	34-35	PIPITA	CONTEMPORARY
38-39	BOEMIA	CONTEMPORARY	98-99	POLAR	CONTEMPORARY
113	CAPRI	BASIC	112	PONZA	BASIC
66-67	CASTEL	CONTEMPORARY	72-73	PRESSBURG	CONTEMPORARY
119	CASTOR	BASIC	190-191	PRESSBURG	ATELIER
10-11	CHIC	CONTEMPORARY	60-61	PRIMA	CONTEMPORARY
102-103	CIGNO	CONTEMPORARY	109	PRIMA MINI	MINIMAL
44-45	CITY	CONTEMPORARY	22-23	Q-CINQUE	CONTEMPORARY
74-75	CLASSIC	CONTEMPORARY	36-37	QUADRA	CONTEMPORARY
117	COMPATTA	BASIC	40-41	QUADRA SPORT	CONTEMPORARY
168	CORNER	INOX	32-33	QUASAR	CONTEMPORARY
20-21	DEA	CONTEMPORARY	182-183	REGINA	ATELIER
96-97	DOLLY	CONTEMPORARY	16-17	RING	CONTEMPORARY
48-49	DUNA	CONTEMPORARY	186-187	RUSTICA	ATELIER
188-189	EPOCA	ATELIER	104-105	SCILLA	CONTEMPORARY
62-63	FORTUNA	CONTEMPORARY	106	SILM	MINIMAL
50-51	GAIA	CONTEMPORARY	24-25	SIRIO	CONTEMPORARY
169	GIRO	INOX	58-59	SMART	CONTEMPORARY
92-93	GRETA	CONTEMPORARY	116	SMART ECO	BASIC
111	ISCHIA	BASIC	86-87	SOLE	CONTEMPORARY
94-95	JOLLY	CONTEMPORARY	80-81	SPIRIT	CONTEMPORARY
124	KARIZ	BASIC	115	SPORT -ALL	BASIC
30-31	LASER	CONTEMPORARY	114	S-QUADRA	BASIC
76-77	LIBERTY	CONTEMPORARY	178-179	STILE	ATELIER
192-193	LUXOR	ATELIER	123	THEMA	BASIC
70-71	MAREA	CONTEMPORARY	180-181	TOSCANA	ATELIER
78-79	MERAK	CONTEMPORARY	68-69	VENUS	CONTEMPORARY
120	MIRA OTTONE	BASIC	8-9	VERA	CONTEMPORARY
121	MIRA ZAMA	BASIC	46-47	YORK	CONTEMPORARY
90-91	MIRADUE	CONTEMPORARY	107	YORK MINI	MINIMAL
82-83	MIZAR	CONTEMPORARY			

VERA





OCR
CROMO LUCIDO
POLISHED CHROME



OLV
OTTONE LUCIDO VERNICIATO
POLISHED AND PAINTED BRASS



CRS
CROMO SATINATO
SATIN CHROME



NE
NERO
BLACK



BNC
BIANCO
WHITE



OBM
BRONZO GRAFFIATO OPACO
YESTER BRONZE

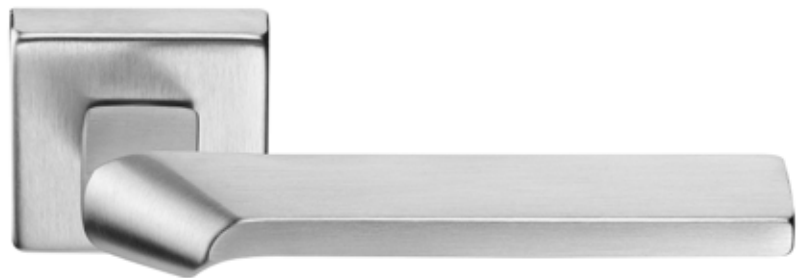

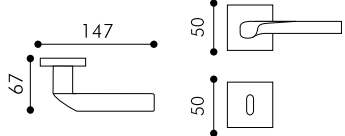
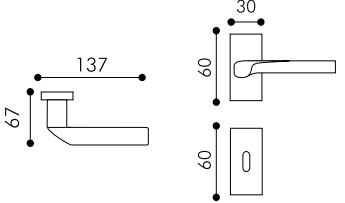
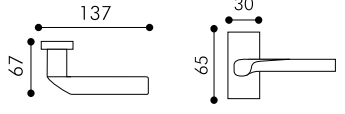
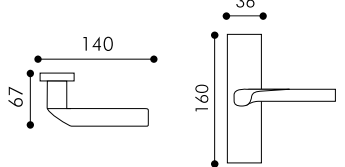
CODICE	DESCRIZIONE	FINITURE	IMBALLO
4701	Guarnitura con molla di ritorno su rosette coprivite e bocchette con foro patent o foro yale. Pair spring handles on roses and escutcheons with patent or cylinder hole.	OCR OLV CRS NE BNC OBM	1 1 1 1 1 1 
4701/R	Guarnitura con molla di ritorno su rosette rettangolari e bocchette con foro patent o foro yale. Pair spring handles on rectangular roses and escutcheons with patent or cylinder hole.	OCR OLV CRS NE BNC OBM	1 1 1 1 1 1 
4702	Maniglia per finestra con movimento DK. Specificare senso d'apertura. (vedi pag. 205) Window handle with DK mechanism.	OCR OLV CRS NE BNC OBM	2 2 2 2 2 2 
4704	Martellina o cremonese per finestra con impugnatura a maniglia su placca. Window handle on plate.	OCR OLV CRS NE BNC OBM	2 2 2 2 2 2 



CHIC



MODELLO DEPOSITATO - REGISTERED MODEL



OCR
CROMO LUCIDO
POLISHED CHROME



OLV
OTTONE LUCIDO VERNICIATO
POLISHED AND PAINTED BRASS



CRS
CROMO SATINATO
SATIN CHROME



NE
NERO
BLACK



BNC
BIANCO
WHITE



OBM
BRONZO GRAFFIATO OPACO
YESTER BRONZE



CODICE	DESCRIZIONE	FINITURE	IMBALLO	
4800	Guarnitura con molla di ritorno su placche con foro patent o yale. Specificare l'interasse. (vedi pag. 204) Pair spring handles on plate with patent or cylinder hole. Specify the wheelbase (see pag. 204)	OCR OLV CRS NE BNC OBM	1 1 1 1 1 1	
4801	Guarnitura con molla di ritorno su rosette coprivite e bocchette con foro patent o foro yale. Pair spring handles on roses and escutcheons with patent or cylinder hole.	OCR OLV CRS NE BNC OBM	1 1 1 1 1 1	
4801/R	Guarnitura con molla di ritorno su rosette ovali e bocchette con foro patent o foro yale. Pair spring handles on oval roses and escutcheons with patent or cylinder hole.	OCR OLV CRS NE BNC OBM	1 1 1 1 1 1	
4802	Maniglia per finestra con movimento DK. Specificare senso d'apertura. (vedi pag. 205) Window handle with DK mechanism.	OCR OLV CRS NE BNC OBM	2 2 2 2 2 2	
4804	Martellina o cremonese per finestra con impugnatura a maniglia su placca. Window handle on plate.	OCR OLV CRS NE BNC OBM	2 2 2 2 2 2	



ZAMA/OTTONE - ZAMAK/BRASS



NIKO

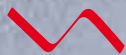



OCR
CROMO LUCIDO
POLISHED CHROME



CRS
CROMO SATINATO
SATIN CHROME



NE
NERO
BLACK



BNC
BIANCO
WHITE

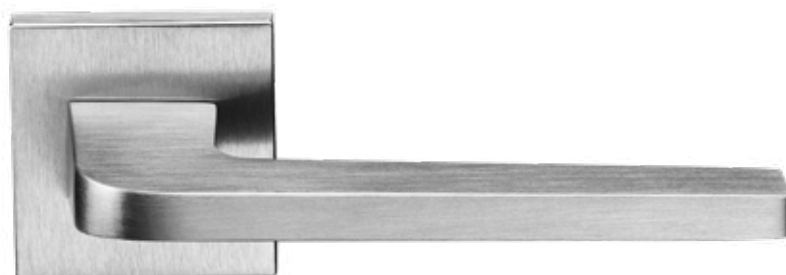

CODICE	DESCRIZIONE	FINITURE	IMBALLO
4501	Guarnitura con molla di ritorno su rosette coprivite e bocchette con foro patent o foro yale. Pair spring handles on roses and escutcheons with patent or cylinder hole.	OCR CRS NE BNC	1 1 1 1
4501/R	Guarnitura con molla di ritorno su rosette rettangolari e bocchette con foro patent o foro yale. Pair spring handles on rectangular roses and escutcheons with patent or cylinder hole.	OCR CRS NE BNC	1 1 1 1
4502	Maniglia per finestra con movimento DK. Window handle with DK mechanism.	OCR CRS NE BNC	2 2 2 2
4504	Martellina o cremonese per finestra con impugnatura a maniglia su placca. Window handle on plate.	OCR CRS NE BNC	2 2 2 2



ARES

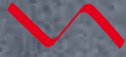



OCR
CROMO LUCIDO
POLISHED CHROME



CRS
CROMO SATINATO
SATIN CHROME



NE
NERO
BLACK



CODICE	DESCRIZIONE	FINITURE	IMBALLO	
4301	Guarnitura con molla di ritorno su rosette coprivite e bocchette con foro patent o foro yale. Pair spring handles on roses and escutcheons with patent or cylinder hole.	OCR CRS NE	1 1 1	
4302	Maniglia per finestra con movimento DK. Window handle with DK mechanism.	OCR CRS NE	1 1 1	
4304	Martellina o cremonese per finestra con impugnatura a maniglia su placca. Window handle on plate.	OCR CRS NE	2 2 2	



RING





OCR
CROMO LUCIDO
POLISHED CHROME



CRS
CROMO SATINATO
SATIN CHROME



NE
NERO
BLACK



BNC
BIANCO
WHITE



CODICE	DESCRIZIONE	FINITURE	IMBALLO	
4600	Guarnitura con molla di ritorno su placche con foro patent o yale. Specify the wheelbase (see pag. 204) Pair spring handles on plate with patent or cylinder hole.	OCR CRS NE BNC	1 1 1 1	
4601	Guarnitura con molla di ritorno su rosette coprivite e bocchette con foro patent o foro yale. Pair spring handles on roses and escutcheons with patent or cylinder hole.	OCR CRS NE BNC	1 1 1 1	
4601/R	Guarnitura con molla di ritorno su rosette ovali e bocchette con foro patent o foro yale. Pair spring handles on oval roses and escutcheons with patent or cylinder hole.	OCR CRS NE BNC	1 1 1 1	
4602	Maniglia per finestra con movimento DK. Window handle with DK mechanism.	OCR CRS NE BNC	2 2 2 2	
4604	Martellina o cremonese per finestra con impugnatura a maniglia su placca. Window handle on plate.	OCR CRS NE BNC	2 2 2 2	



AREA 51





ECRS
EFFETTO CROMO SATINATO
SATIN CHROME EFFECT



NE
NERO
BLACK



BNC
BIANCO
WHITE



CODICE	DESCRIZIONE	FINITURE	IMBALLO	
9081	Guarnitura con molla di ritorno su rosette coprivite e bocchette da 8 mm con foro patent o foro yale. Pair spring handles on 8 mm roses and escutcheons with patent or cylinder hole.	ECRS NE BNC	1 1 1	
9082	Maniglia per finestra con movimento DK. Specificare senso d'apertura. (vedi pag. 205) Window handle with DK mechanism.	ECRS NE BNC	2 2 2	



DEA





PVD
OTTONE LUCIDO PVD
PVD POLISHED BRASS



OCR
CROMO LUCIDO
POLISHED CHROME



CRS
CROMO SATINATO
SATIN CHROME



OBM
BRONZO GRAFFIATO OPACO
YESTER BRONZE



CODICE	DESCRIZIONE	FINITURE	IMBALLO	
2201	Guarnitura con molla di ritorno su rosette coprivite e bocchette con foro patent o foro yale. Pair spring handles on roses and escutcheons with patent or cylinder hole.	PVD OCR CRS OBM	1 1 1 1	
2202	Maniglia per finestra con movimento DK. Window handle with DK mechanism.	PVD OCR CRS OBM	1 1 1 1	
2203	Martellina o cremonese per finestra su placca. Window handle on plate.	PVD OCR CRS OBM	2 2 2 2	
2203/F	Martellina o cremonese per finestra su placca con viti a vista. Window handle on plate with screw holes.	PVD OCR CRS OBM	2 2 2 2	



Q-CINQUE

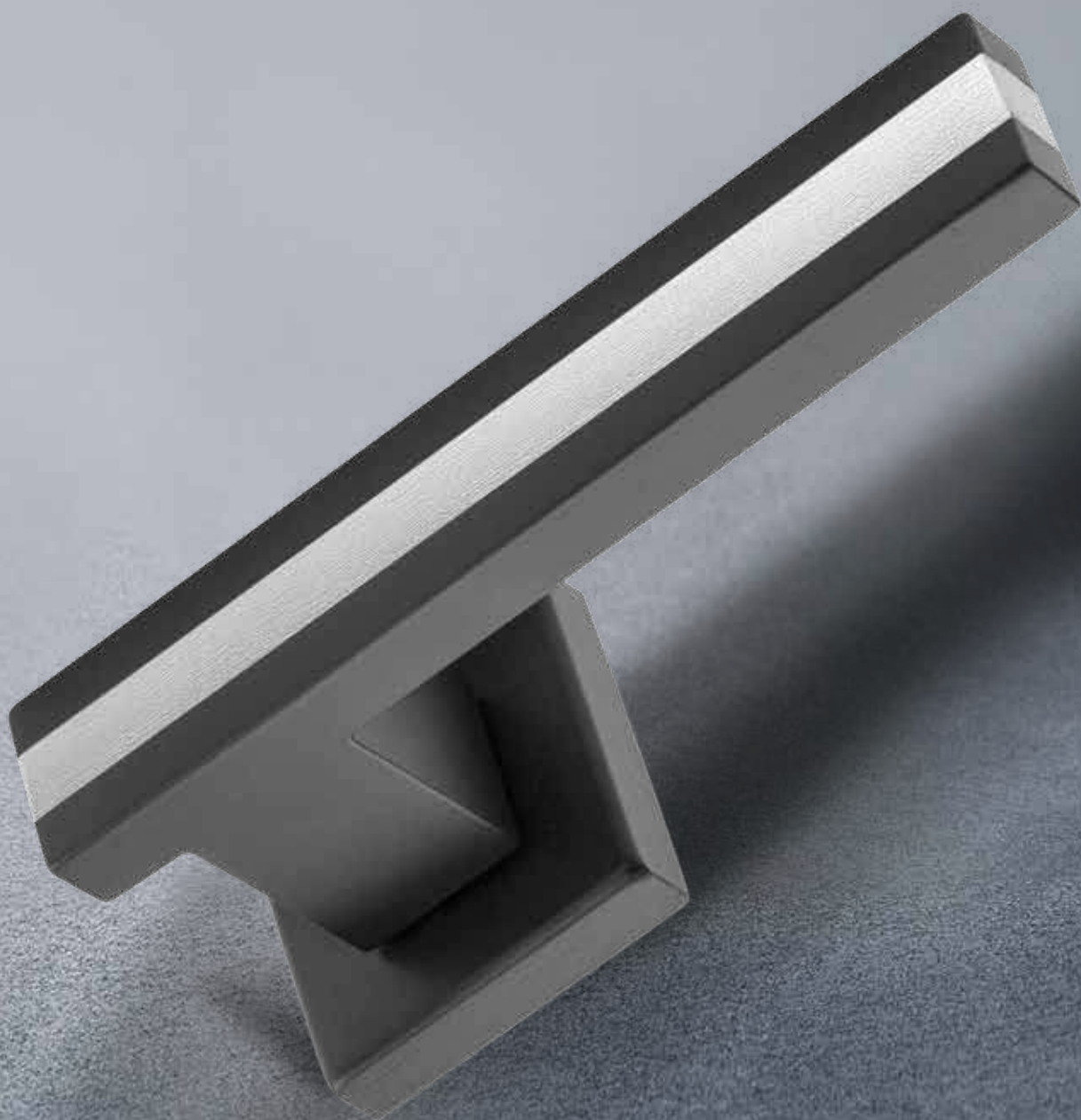

MODELLO DEPOSITATO - REGISTERED MODEL



OCR
CROMO LUCIDO
POLISHED CHROME



CRS
CROMO SATINATO
SATIN CHROME



NE
NERO
BLACK



NE/CRS
NERO/CROMO SATINATO
BLACK/SATIN CHROME



CODICE	DESCRIZIONE	FINITURE	IMBALLO	
9031	Guarnitura con molla di ritorno su rosette coprivite e bocchette con foro patent o foro yale. Pair spring handles on roses and escutcheons with patent or cylinder hole.	OCR CRS NE NE/CRS	1 1 1 1	
9032	Maniglia per finestra con movimento DK. Window handle with DK mechanism.	OCR CRS NE NE/CRS	1 1 1 1	
9034	Martellina o cremonese per finestra con impugnatura a maniglia su placca. Window handle on plate.	OCR CRS NE NE/CRS	2 2 2 2	



SIRIO

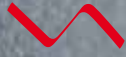



CRS
CROMO SATINATO
SATIN CHROME

OCR/CRS
BICOLOR CROMO LUC/SAT
POLISHED/SATIN CHROME

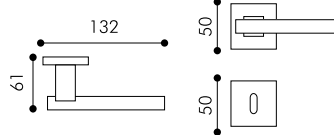
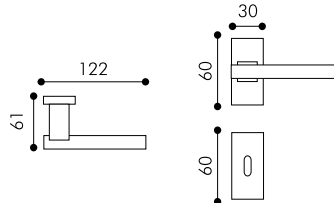
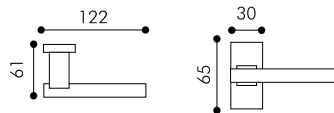
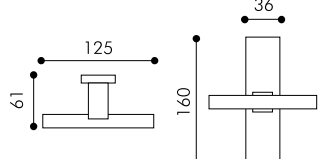

CODICE	DESCRIZIONE	FINITURE	IMBALLO
9051	Guarnitura con molla di ritorno su rosette coprivite e bocchette con foro patent o foro yale. Pair spring handles on roses and escutcheons with patent or cylinder hole.	CRS OCR/CRS	1 1 
9051/R	Guarnitura con molla di ritorno su rosette rettangolari e bocchette con foro patent o foro yale. Pair spring handles on rectangular roses and escutcheons with patent or cylinder hole.	CRS OCR/CRS	1 1 
9052	Maniglia per finestra con movimento DK. Window handle with DK mechanism.	CRS OCR/CRS	2 2 
9053	Martellina o cremonese per finestra su placca. Window handle on plate.	CRS OCR/CRS	2 2 



OTTONE - BRASS



B-52





CRS
CROMO SATINATO
SATIN CHROME



NE
NERO
BLACK



BNC
BIANCO
WHITE

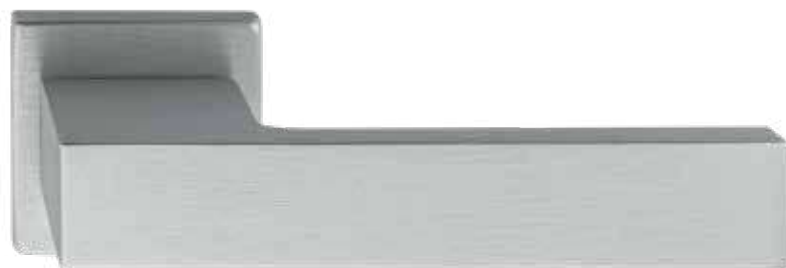

CODICE	DESCRIZIONE	FINITURE	IMBALLO
--------	-------------	----------	---------

9091

Guarnitura con molla di ritorno su rosette coprivite e bocchette con foro patent o foro yale.

Pair spring handles on roses and escutcheons with patent or cylinder hole.

CRS
NE
BNC

1
1
1

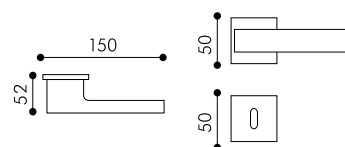

9092

Maniglia per finestra con movimento DK. Specificare senso d'apertura. (vedi pag. 205)

Window handle with DK mechanism.

CRS
NE
BNC

2
2
2

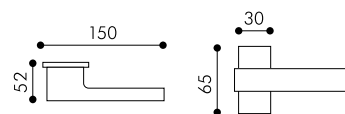

PIEGO





OLV
OTTONE LUCIDO VERNICIATO
POLISHED AND PAINTED BRASS



CRS
CROMO SATINATO
SATIN CHROME



OCR/CRS
BICOLOR CROMO LUC/SAT
POLISHED/SATIN CHROME

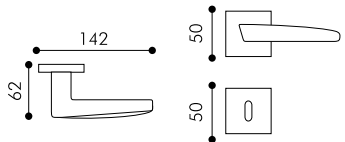
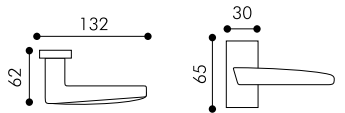
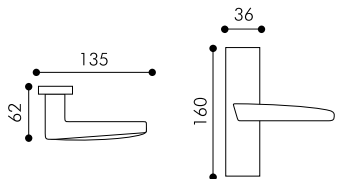

CODICE	DESCRIZIONE	FINITURE	IMBALLO
4901	Guarnitura con molla di ritorno su rosette coprivite e bocchette con foro patent o foro yale. Pair spring handles on roses and escutcheons with patent or cylinder hole.	OLV CRS OCR/CRS	1 1 1 
4902	Maniglia per finestra con movimento DK. Specificare senso d'apertura. (vedi pag. 205) Window handle with DK mechanism.	OLV CRS OCR/CRS	1 1 1 
4904	Martellina o cremonese per finestra con impugnatura a maniglia su placca. Window handle on plate.	OLV CRS OCR/CRS	2 2 2 



LASER



MODELLO DEPOSITATO - REGISTERED MODEL



OCR
CROMO LUCIDO
POLISHED CHROME



CRS
CROMO SATINATO
SATIN CHROME



NE
NERO
BLACK



BNC
BIANCO
WHITE



OBM
BRONZO GRAFFIATO OPACO
YESTER BRONZE



CODICE	DESCRIZIONE	FINITURE	IMBALLO
4400	<p>Guarnitura con molla di ritorno su placche con foro patent o yale. Specificare l'interasse. (vedi pag. 204)</p> <p>Pair spring handles on plate with patent or cylinder hole. Specify the wheelbase (see pag. 204)</p>	<p>OCR</p> <p>CRS</p> <p>NE</p> <p>BNC</p> <p>OBM</p>	<p>1</p> <p>1</p> <p>1</p> <p>1</p> <p>1</p>
4401	<p>Guarnitura con molla di ritorno su rosette coprivite e bocchette con foro patent o foro yale.</p> <p>Pair spring handles on roses and escutcheons with patent or cylinder hole.</p>	<p>OCR</p> <p>CRS</p> <p>NE</p> <p>BNC</p> <p>OBM</p>	<p>1</p> <p>1</p> <p>1</p> <p>1</p> <p>1</p>
4402	<p>Maniglia per finestra con movimento DK.</p> <p>Window handle with DK mechanism.</p>	<p>OCR</p> <p>CRS</p> <p>NE</p> <p>BNC</p> <p>OBM</p>	<p>2</p> <p>2</p> <p>2</p> <p>2</p> <p>2</p>
4404	<p>Martellina o cremonese per finestra con impugnatura a maniglia su placca.</p> <p>Window handle on plate.</p>	<p>OCR</p> <p>CRS</p> <p>NE</p> <p>BNC</p> <p>OBM</p>	<p>1</p> <p>1</p> <p>1</p> <p>1</p> <p>1</p>



QUASAR

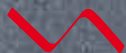

MODELLO DEPOSITATO - REGISTERED MODEL



OCR
CROMO LUCIDO
POLISHED CHROME



CRS
CROMO SATINATO
SATIN CHROME



NE
NERO
BLACK



BNC
BIANCO
WHITE



OBM
BRONZO GRAFFIATO OPACO
YESTER BRONZE



CODICE	DESCRIZIONE	FINITURE	IMBALLO
4201	Guarnitura con molla di ritorno su rosette coprivite e bocchette con foro patent o foro yale. Pair spring handles on roses and escutcheons with patent or cylinder hole.	OCR CRS NE BNC OBM	1 1 1 1 1
4201/R	Guarnitura con molla di ritorno su rosette rettangolari e bocchette con foro patent o foro yale. Pair spring handles on rectangular roses and escutcheons with patent or cylinder hole.	OCR CRS NE BNC OBM	1 1 1 1 1
4202	Maniglia per finestra con movimento DK. Window handle with DK mechanism.	OCR CRS NE BNC OBM	2 2 2 2 2
4204	Martellina o cremonese per finestra con impugnatura a maniglia su placca. Window handle on plate.	OCR CRS NE BNC OBM	2 2 2 2 2



PIPITA





OCR
CROMO LUCIDO
POLISHED CHROME

CRS
CROMO SATINATO
SATIN CHROME



CODICE	DESCRIZIONE	FINITURE	IMBALLO
9020	<p>Guarnitura con molla di ritorno su placche con foro patent o yale. Specificare l'interasse. (vedi pag. 204)</p> <p>Pair spring handles on plate with patent or cylinder hole. Specify the wheelbase (see pag. 204)</p>	<p>OCR</p> <p>CRS</p>	<p>1</p> <p>1</p>
9021	<p>Guarnitura con molla di ritorno su rosette coprivite e bocchette con foro patent o foro yale.</p> <p>Pair spring handles on roses and escutcheons with patent or cylinder hole.</p>	<p>OCR</p> <p>CRS</p>	<p>1</p> <p>1</p>
9022	<p>Maniglia per finestra con movimento DK.</p> <p>Window handle with DK mechanism.</p>	<p>OCR</p> <p>CRS</p>	<p>2</p> <p>2</p>
9024	<p>Martellina o cremonese per finestra con impugnatura a maniglia su placca.</p> <p>Window handle on plate.</p>	<p>OCR</p> <p>CRS</p>	<p>1</p> <p>1</p>



QUADRA

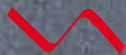



PVD
OTTONE LUCIDO PVD
PVD POLISHED BRASS



OCR
CROMO LUCIDO
POLISHED CHROME



CRS
CROMO SATINATO
SATIN CHROME



OBM
BRONZO GRAFFIATO OPACO
YESTER BRONZE



NKS
NIKEL SATINATO
SATIN NIKEL



NE
NERO
BLACK



BNC
BIANCO
WHITE



CODICE	DESCRIZIONE	FINITURE	IMBALLO	
9061	Guarnitura con molla di ritorno su rosette coprivite e bocchette con foro patent o foro yale. Pair spring handles on roses and escutcheons with patent or cylinder hole.	PVD OCR CRS OBM NKS NE BNC	1 1 1 1 1 1 1	
9061/R	Guarnitura con molla di ritorno su rosette rettangolari e bocchette con foro patent o foro yale. Pair spring handles on rectangular roses and escutcheons with patent or cylinder hole.	PVD OCR CRS OBM NKS NE BNC	1 1 1 1 1 1 1	
9062	Maniglia per finestra con movimento DK. Window handle with DK mechanism.	PVD OCR CRS OBM NKS NE BNC	2 2 2 2 2 2 2	
9064	Martellina o cremonese per finestra con impugnatura a maniglia su placca. Window handle on plate.	PVD OCR CRS OBM NKS NE BNC	2 2 2 2 2 2 2	



BOEMIA





OCR
CROMO LUCIDO
POLISHED CHROME

OCR/CRS
BICOLOR CROMO LUC/SAT
POLISHED/SATIN CHROME

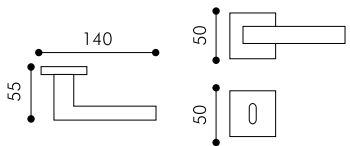
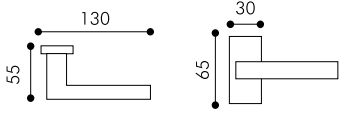
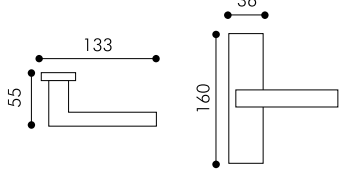

Cristal White

CODICE	DESCRIZIONE	FINITURE	IMBALLO
2301	Guarnitura con molla di ritorno su rosette coprivite e bocchette con foro patent o foro yale. Pair spring handles on roses and escutcheons with patent or cylinder hole.	OCR OCR/CRS	1 1 
2302	Maniglia per finestra con movimento DK. Window handle with DK mechanism.	OCR OCR/CRS	1 1 
2304	Martellina o cremonese per finestra con impugnatura a maniglia su placca. Window handle on plate.	OCR OCR/CRS	2 2 



QUADRA SPORT

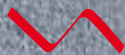



PVD
OTTONE LUCIDO PVD
PVD POLISHED BRASS

OCR
CROMO LUCIDO
POLISHED CHROME

CRS
CROMO SATINATO
SATIN CHROME

OCR/CRS
BICOLOR CROMO LUC/SAT
POLISHED/SATIN CHROME

OCR/CRS 2
BICOLOR CROMO LUC/SAT
POLISHED/SATIN CHROME

NE
NERO
BLACK

BNC
BIANCO
WHITE

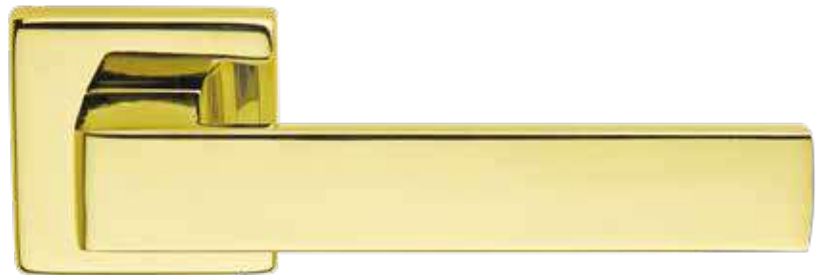

CODICE	DESCRIZIONE	FINITURE	IMBALLO	
8091	Guarnitura con molla di ritorno su rosette coprivite e bocchette con foro patent o foro yale. Pair spring handles on roses and escutcheons with patent or cylinder hole.	PVD OCR CRS OCR/CRS OCR/CRS 2 NE BNC	1 1 1 1 1 1 1	
8091/R	Guarnitura con molla di ritorno su rosette rettangolari e bocchette con foro patent o foro yale. Pair spring handles on rectangular roses and escutcheons with patent or cylinder hole.	PVD OCR CRS OCR/CRS OCR/CRS 2 NE BNC	1 1 1 1 1 1 1	
8092	Maniglia per finestra con movimento DK. Window handle with DK mechanism.	PVD OCR CRS OCR/CRS OCR/CRS 2 NE BNC	2 2 2 2 2 2 2	
8094	Martellina o cremonese per finestra con impugnatura a maniglia su placca. Window handle on plate.	PVD OCR CRS OCR/CRS OCR/CRS 2 NE BNC	2 2 2 2 2 2 2	



BELLA

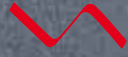



CRS
CROMO SATINATO
SATIN CHROME

OCR/CRS
BICOLOR CROMO LUC/SAT
POLISHED/SATIN CHROME



CODICE	DESCRIZIONE	FINITURE	IMBALLO	
2701	Guarnitura con molla di ritorno su rosette coprivite e bocchette con foro patent o foro yale. Pair spring handles on roses and escutcheons with patent or cylinder hole.	CRS OCR/CRS	1 1	
2701/R	Guarnitura con molla di ritorno su rosette rettangolari e bocchette con foro patent o foro yale. Pair spring handles on rectangular roses and escutcheons with patent or cylinder hole.	CRS OCR/CRS	1 1	
2702	Maniglia per finestra con movimento DK. Specificare senso d'apertura. (vedi pag. 205) Window handle with DK mechanism.	CRS OCR/CRS	2 2	
2704	Martellina o cremonese per finestra con impugnatura a maniglia su placca. Window handle on plate.	CRS OCR/CRS	2 2	



CITY





CRS
CROMO SATINATO
SATIN CHROME



OCR/CRS
BICOLOR CROMO LUC/SAT
POLISHED/SATIN CHROME



NE/CRS
NERO/CROMO SATINATO
BLACK/SATIN CHROME



CODICE	DESCRIZIONE	FINITURE	IMBALLO	
9151	Guarnitura con molla di ritorno su rosette coprivite e bocchette con foro patent o foro yale. Pair spring handles on roses and escutcheons with patent or cylinder hole.	CRS OCR/CRS NE/CRS	1 1 1	
9151/R	Guarnitura con molla di ritorno su rosette rettangolari e bocchette con foro patent o foro yale. Pair spring handles on rectangular roses and escutcheons with patent or cylinder hole.	CRS OCR/CRS NE/CRS	1 1 1	
9152	Maniglia per finestra con movimento DK. Window handle with DK mechanism.	CRS OCR/CRS NE/CRS	2 2 2	
9154	Martellina o cremonese per finestra con impugnatura a maniglia su placca. Window handle on plate.	CRS OCR/CRS NE/CRS	2 2 2	



YORK

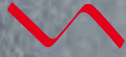



CRS
CROMO SATINATO
SATIN CHROME



OCR/CRS
BICOLOR CROMO LUC/SAT
POLISHED/SATIN CHROME



NE/OCR
BICOLOR NERO/CROMO LUC
BLACK/POLISHED CHROME



CODICE	DESCRIZIONE	FINITURE	IMBALLO	
9251	Guarnitura con molla di ritorno su rosette coprivite e bocchette con foro patent o foro yale. Pair spring handles on roses and escutcheons with patent or cylinder hole.	CRS OCR/CRS NE/OCR	1 1 1	
9251/R	Guarnitura con molla di ritorno su rosette ovali e bocchette con foro patent o foro yale. Pair spring handles on oval roses and escutcheons with patent or cylinder hole.	CRS OCR/CRS NE/OCR	1 1 1	
9252	Maniglia per finestra con movimento DK. Window handle with DK mechanism.	CRS OCR/CRS NE/OCR	2 2 2	
9254	Martellina o cremonese per finestra con impugnatura a maniglia su placca. Window handle on plate.	CRS OCR/CRS NE/OCR	2 2 2	



DUNA





OLV
OTTONE LUCIDO VERNICIATO
POLISHED AND PAINTED BRASS



OCR
CROMO LUCIDO
POLISHED CHROME



CRS
CROMO SATINATO
SATIN CHROME



CODICE	DESCRIZIONE	FINITURE	IMBALLO	
7800	Guarnitura con molla di ritorno su placche con foro patent o yale. Specificare l'interasse. (vedi pag. 204) Pair spring handles on plate with patent or cylinder hole. Specify the wheelbase (see pag. 204)	OLV OCR CRS	1 1 1	
7801	Guarnitura con molla di ritorno su rosette coprivite e bocchette con foro patent o foro yale. Pair spring handles on roses and escutcheons with patent or cylinder hole.	OLV OCR CRS	1 1 1	
7802	Maniglia per finestra con movimento DK. Window handle with DK mechanism.	OLV OCR CRS	2 2 2	
7804	Martellina o cremonese per finestra con impugnatura a maniglia su placca. Window handle on plate.	OLV OCR CRS	2 2 2	



GAIA





OCR
CROMO LUCIDO
POLISHED CHROME

CRS
CROMO SATINATO
SATIN CHROME



CODICE	DESCRIZIONE	FINITURE	IMBALLO
3100	<p>Guarnitura con molla di ritorno su placche con foro patent o yale. Specificare l'interasse. (vedi pag. 204)</p> <p>Pair spring handles on plate with patent or cylinder hole. Specify the wheelbase (see pag. 204)</p>	<p>OCR</p> <p>CRS</p>	<p>1</p> <p>1</p>
3101	<p>Guarnitura con molla di ritorno su rosette coprivite e bocchette con foro patent o foro yale.</p> <p>Pair spring handles on roses and escutcheons with patent or cylinder hole.</p>	<p>OCR</p> <p>CRS</p>	<p>1</p> <p>1</p>
3102	<p>Maniglia per finestra con movimento DK.</p> <p>Window handle with DK mechanism.</p>	<p>OCR</p> <p>CRS</p>	<p>2</p> <p>2</p>
3104	<p>Martellina o cremonese per finestra con impugnatura a maniglia su placca.</p> <p>Window handle on plate.</p>	<p>OCR</p> <p>CRS</p>	<p>2</p> <p>2</p>



OPERA





OLV
OTTONE LUCIDO VERNICIATO
POLISHED AND PAINTED BRASS



OCR
CROMO LUCIDO
POLISHED CHROME



CRS
CROMO SATINATO
SATIN CHROME



OBM
BRONZO GRAFFIATO OPACO
YESTER BRONZE

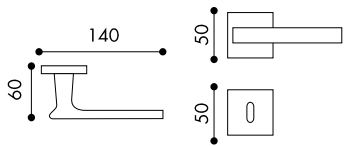
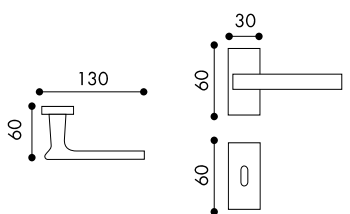
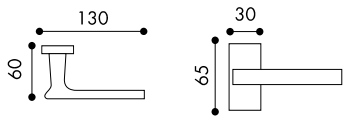
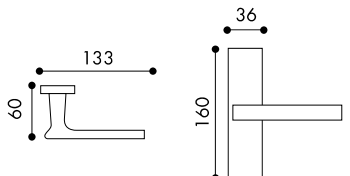

CODICE	DESCRIZIONE	FINITURE	IMBALLO
4061	Guarnitura con molla di ritorno su rosette coprivite e bocchette con foro patent o foro yale. Pair spring handles on roses and escutcheons with patent or cylinder hole.	OLV OCR CRS OBM	1 1 1 1 
4061/R	Guarnitura con molla di ritorno su rosette rettangolari e bocchette con foro patent o foro yale. Pair spring handles on rectangular roses and escutcheons with patent or cylinder hole.	OLV OCR CRS OBM	1 1 1 1 
4062	Maniglia per finestra con movimento DK. Window handle with DK mechanism.	OLV OCR CRS OBM	2 2 2 2 
4064	Martellina o cremonese per finestra con impugnatura a maniglia su placca. Window handle on plate.	OLV OCR CRS OBM	2 2 2 2 



MODERNA

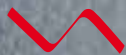



OCR
CROMO LUCIDO
POLISHED CHROME



CRS
CROMO SATINATO
SATIN CHROME



NE
NERO
BLACK



CODICE	DESCRIZIONE	FINITURE	IMBALLO	
3301	Guarnitura con molla di ritorno su rosette coprivite e bocchette con foro patent o foro yale. Pair spring handles on roses and escutcheons with patent or cylinder hole.	OCR CRS NE	1 1 1	
3301/R	Guarnitura con molla di ritorno su rosette rettangolari e bocchette con foro patent o foro yale. Pair spring handles on rectangular roses and escutcheons with patent or cylinder hole.	OCR CRS NE	1 1 1	
3302	Maniglia per finestra con movimento DK. Window handle with DK mechanism.	OCR CRS NE	2 2 2	
3304	Martellina o cremonese per finestra con impugnatura a maniglia su placca. Window handle on plate.	OCR CRS NE	2 2 2	



PEGASO

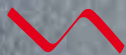



OLV
OTTONE LUCIDO VERNICIATO
POLISHED AND PAINTED BRASS



OCR
CROMO LUCIDO
POLISHED CHROME



CRS
CROMO SATINATO
SATIN CHROME



CODICE	DESCRIZIONE	FINITURE	IMBALLO	
7091	Guarnitura con molla di ritorno su rosette coprivite e bocchette con foro patent o foro yale. Pair spring handles on roses and escutcheons with patent or cylinder hole.	OLV OCR CRS	1 1 1	
7091/R	Guarnitura con molla di ritorno su rosette rettangolari e bocchette con foro patent o foro yale. Pair spring handles on rectangular roses and escutcheons with patent or cylinder hole.	OLV OCR CRS	1 1 1	
7092	Maniglia per finestra con movimento DK. Window handle with DK mechanism.	OLV OCR CRS	2 2 2	
7094	Martellina o cremonese per finestra con impugnatura a maniglia su placca. Window handle on plate.	OLV OCR CRS	2 2 2	



SMART





ROSETTA DA:
50x50 mm

OCR
CROMO LUCIDO
POLISHED CHROME

CRS
CROMO SATINATO
SATIN CHROME

ROSETTA DA:
45x45 mm

OCR
CROMO LUCIDO
POLISHED CHROME

CRS
CROMO SATINATO
SATIN CHROME

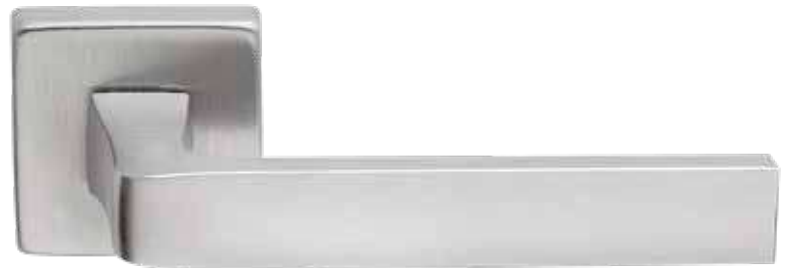

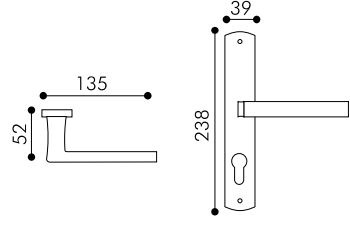
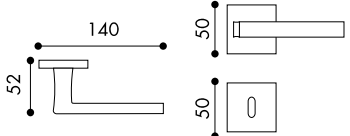
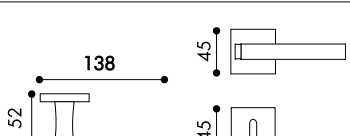
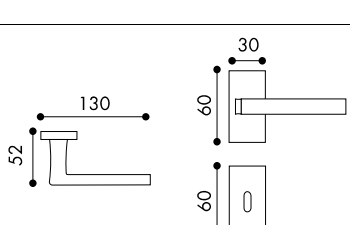
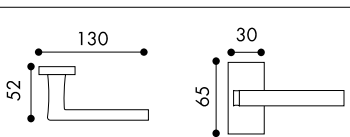
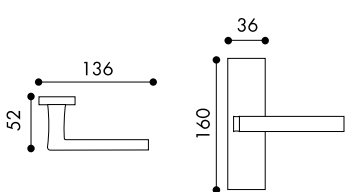
CODICE	DESCRIZIONE	FINITURE	IMBALLO	
6080	Guarnitura con molla di ritorno su placche con foro patent o yale. Specificare l'interasse. (vedi pag. 204) Pair spring handles on plate with patent or cylinder hole. Specify the wheelbase (see pag. 204)	OCR CRS	1 1	
6081/50	Guarnitura con molla di ritorno su rosette coprivite e bocchette con foro patent o foro yale. Pair spring handles on roses and escutcheons with patent or cylinder hole.	OCR CRS	2 2	
6081/45	Guarnitura con molla di ritorno su rosette coprivite e bocchette con foro patent o foro yale. Pair spring handles on roses and escutcheons with patent or cylinder hole.	OCR CRS	1 1	
6081/R	Guarnitura con molla di ritorno su rosette rettangolari e bocchette con foro patent o foro yale. Pair spring handles on rectangular roses and escutcheons with patent or cylinder hole.	OCR CRS	2 2	
6082	Maniglia per finestra con movimento DK. Window handle with DK mechanism.	OCR CRS	4 4	
6084	Martellina o cremonese per finestra con impugnatura a maniglia su placca. Window handle on plate.	OCR CRS	2 2	



PRIMA





OLV
OTTONE LUCIDO VERNICIATO
POLISHED AND PAINTED BRASS



OCR
CROMO LUCIDO
POLISHED CHROME



CRS
CROMO SATINATO
SATIN CHROME



CODICE	DESCRIZIONE	FINITURE	IMBALLO
3400	Guarnitura con molla di ritorno su placche con foro patent o yale. Specificare l'interasse. (vedi pag. 204) Pair spring handles on plate with patent or cylinder hole. Specify the wheelbase (see pag. 204)	OLV OCR CRS	1 1 1
3401	Guarnitura con molla di ritorno su rosette coprivite e bocchette con foro patent o foro yale. Pair spring handles on roses and escutcheons with patent or cylinder hole.	OLV OCR CRS	1 1 1
3402	Maniglia per finestra con movimento DK. Specificare senso d'apertura. (vedi pag. 205) Window handle with DK mechanism.	OLV OCR CRS	2 2 2
3404	Martellina o cremonese per finestra con impugnatura a maniglia su placca. Window handle on plate.	OLV OCR CRS	2 2 2



FORTUNA





OLV/OSL
BICOLOR OTTONE LUC/SAT
POLISHED/SATIN BRASS



OCR/CRS
BICOLOR CROMO LUC/SAT
POLISHED/SATIN CHROME

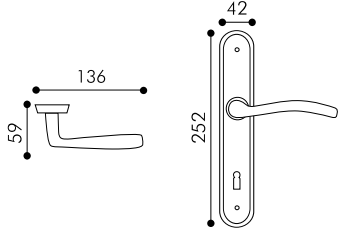
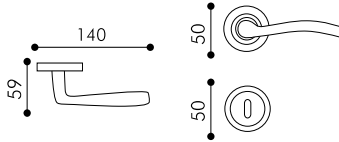
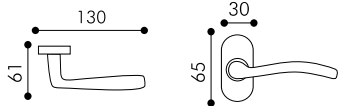
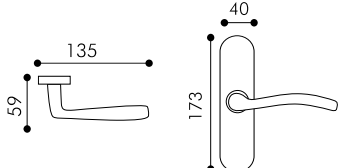

CODICE	DESCRIZIONE	FINITURE	IMBALLO
6050	<p>Guarnitura con molla di ritorno su placche con foro patent o yale. Specificare l'interasse. (vedi pag. 204)</p> <p>Pair spring handles on plate with patent or cylinder hole. Specify the wheelbase (see pag. 204)</p>	<p>OLV/OSL</p> <p>OCR/CRS</p>	<p>1</p> <p>1</p> 
6051	<p>Guarnitura con molla di ritorno su rosette coprivite e bocchette con foro patent o foro yale.</p> <p>Pair spring handles on roses and escutcheons with patent or cylinder hole.</p>	<p>OLV/OSL</p> <p>OCR/CRS</p>	<p>1</p> <p>1</p> 
6052	<p>Maniglia per finestra con movimento DK. Specificare senso d'apertura. (vedi pag. 205)</p> <p>Window handle with DK mechanism.</p>	<p>OLV/OSL</p> <p>OCR/CRS</p>	<p>2</p> <p>2</p> 
6054	<p>Martellina o cremonese per finestra con impugnatura a maniglia su placca.</p> <p>Window handle on plate.</p>	<p>OLV/OSL</p> <p>OCR/CRS</p>	<p>2</p> <p>2</p> 



ONDA





OLV
OTTONE LUCIDO VERNICIATO
POLISHED AND PAINTED BRASS



OCR
CROMO LUCIDO
POLISHED CHROME



CRS
CROMO SATINATO
SATIN CHROME



CODICE	DESCRIZIONE	FINITURE	IMBALLO	
6090	Guarnitura con molla di ritorno su placche con foro patent o yale. Specificare l'interasse. (vedi pag. 204) Pair spring handles on plate with patent or cylinder hole. Specify the wheelbase (see pag. 204)	OLV OCR CRS	1 1 1	
6091	Guarnitura con molla di ritorno su rosette coprivite e bocchette con foro patent o foro yale. Pair spring handles on roses and escutcheons with patent or cylinder hole.	OLV OCR CRS	1 1 1	
6092	Maniglia per finestra con movimento DK. Specificare senso d'apertura. (vedi pag. 205) Window handle with DK mechanism.	OLV OCR CRS	2 2 2	
6094	Martellina o cremonese per finestra con impugnatura a maniglia su placca. Window handle on plate.	OLV OCR CRS	2 2 2	



CASTEL





OLV
OTTONE LUCIDO VERNICIATO
POLISHED AND PAINTED BRASS



ANT
BRONZO ANTICO OPACO
ANTIQU BRONZE



NA
NIKEL NERO FERROANTICO
ANTIQU SILVER



CODICE	DESCRIZIONE	FINITURE	IMBALLO	
1150	Guarnitura con molla di ritorno su placche con foro patent o yale. Specificare l'interasse. (vedi pag. 204) Pair spring handles on plate with patent or cylinder hole. Specify the wheelbase (see pag. 204)	OLV ANT NA	1 1 1	
1151	Guarnitura con molla di ritorno su rosette coprivite e bocchette con foro patent o foro yale. Pair spring handles on roses and escutcheons with patent or cylinder hole.	OLV ANT NA	1 1 1	
1152	Maniglia per finestra con movimento DK. Specificare senso d'apertura. (vedi pag. 205) Window handle with DK mechanism.	OLV ANT NA	2 2 2	
1154	Martellina o cremonese per finestra con impugnatura a maniglia su placca. Window handle on plate.	OLV ANT NA	2 2 2	



VENUS





OLV
OTTONE LUCIDO VERNICIATO
POLISHED AND PAINTED BRASS



OCR
CROMO LUCIDO
POLISHED CHROME



CRS
CROMO SATINATO
SATIN CHROME



OBM
BRONZO GRAFFIATO OPACO
YESTER BRONZE



CODICE	DESCRIZIONE	FINITURE	IMBALLO	
5050	Guarnitura con molla di ritorno su placche con foro patent o yale. Specificare l'interasse. (vedi pag. 204) Pair spring handles on plate with patent or cylinder hole. Specify the wheelbase (see pag. 204)	OLV OCR CRS OBM	1 1 1 1	
5051	Guarnitura con molla di ritorno su rosette coprivite e bocchette con foro patent o foro yale. Pair spring handles on roses and escutcheons with patent or cylinder hole.	OLV OCR CRS OBM	1 1 1 1	
5052	Maniglia per finestra con movimento DK. Window handle with DK mechanism.	OLV OCR CRS OBM	2 2 2 2	
5054	Martellina o cremonese per finestra con impugnatura a maniglia su placca. Window handle on plate.	OLV OCR CRS OBM	2 2 2 2	



MAREA





OLV
OTTONE LUCIDO VERNICIATO
POLISHED AND PAINTED BRASS



OCR
CROMO LUCIDO
POLISHED CHROME



CRS
CROMO SATINATO
SATIN CHROME



OCR/CRS
BICOLOR CROMO LUC/SAT
POLISHED/SATIN CHROME



OBG
BRONZO GRAFFIATO LUCIDO
SCRATCHED POLISHED BRONZE



CODICE	DESCRIZIONE	FINITURE	IMBALLO
8030	<p>Guarnitura con molla di ritorno su placche con foro patent o yale. Specificare l'interasse. (vedi pag. 204)</p> <p>Pair spring handles on plate with patent or cylinder hole. Specify the wheelbase (see pag. 204)</p>	<p>OLV OCR CRS OCR/CRS OBG</p>	<p>1 1 1 1 1</p>
8031	<p>Guarnitura con molla di ritorno su rosette coprivite e bocchette con foro patent o foro yale.</p> <p>Pair spring handles on roses and escutcheons with patent or cylinder hole.</p>	<p>OLV OCR CRS OCR/CRS OBG</p>	<p>2 2 2 2 2</p>
8032	<p>Maniglia per finestra con movimento DK.</p> <p>Window handle with DK mechanism.</p>	<p>OLV OCR CRS OCR/CRS OBG</p>	<p>4 4 4 4 4</p>



PRESSBURG

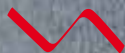



OLV
OTTONE LUCIDO VERNICIATO
POLISHED AND PAINTED BRASS



OCR
CROMO LUCIDO
POLISHED CHROME



CRS
CROMO SATINATO
SATIN CHROME



OBM
BRONZO GRAFFIATO OPACO
YESTER BRONZE



CODICE	DESCRIZIONE	FINITURE	IMBALLO	
5070	Guarnitura con molla di ritorno su placche con foro patent o yale. Specificare l'interasse. (vedi pag. 204) Pair spring handles on plate with patent or cylinder hole. Specify the wheelbase (see pag. 204)	OLV OCR CRS OBM	1 1 1 1	
5071	Guarnitura con molla di ritorno su rosette coprivite e bocchette con foro patent o foro yale. Pair spring handles on roses and escutcheons with patent or cylinder hole.	OLV OCR CRS OBM	1 1 1 1	
5072	Maniglia per finestra con movimento DK. Window handle with DK mechanism.	OLV OCR CRS OBM	2 2 2 2	
5073	Martellina o cremonese per finestra su placca con viti a vista. Window handle on plate with screw holes.	OLV OCR CRS OBM	2 2 2 2	



CLASSIC





OLV
OTTONE LUCIDO VERNICIATO
POLISHED AND PAINTED BRASS



OCR
CROMO LUCIDO
POLISHED CHROME



CRS
CROMO SATINATO
SATIN CHROME



OBG
BRONZO GRAFFIATO LUCIDO
SCRATCHED POLISHED BRONZE

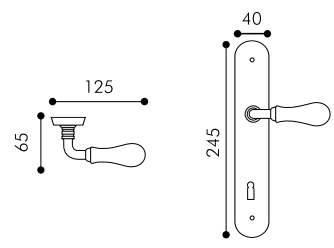
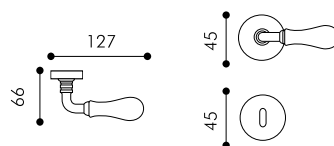
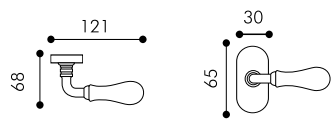
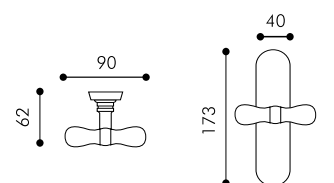

CODICE	DESCRIZIONE	FINITURE	IMBALLO
1860	Guarnitura con molla di ritorno su placche con foro patent o yale. Specificare l'interasse. (vedi pag. 204) Pair spring handles on plate with patent or cylinder hole. Specify the wheelbase (see pag. 204)	OLV OCR CRS OBG	1 1 1 1 
1861	Guarnitura con molla di ritorno su rosette coprivite e bocchette con foro patent o foro yale. Pair spring handles on roses and escutcheons with patent or cylinder hole.	OLV OCR CRS OBG	1 1 1 1 
1862	Maniglia per finestra con movimento DK. Window handle with DK mechanism.	OLV OCR CRS OBG	2 2 2 2 
1863	Martellina o cremonese per finestra su placca. Window handle on plate.	OLV OCR CRS OBG	2 2 2 2 



LIBERTY

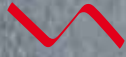



OLV
OTTONE LUCIDO VERNICIATO
POLISHED AND PAINTED BRASS



OCR
CROMO LUCIDO
POLISHED CHROME



CRS
CROMO SATINATO
SATIN CHROME



OBM
BRONZO GRAFFIATO OPACO
YESTER BRONZE

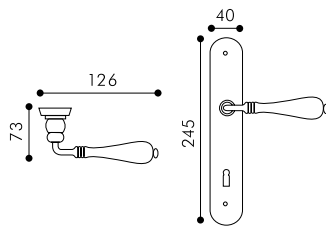
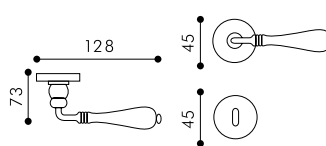
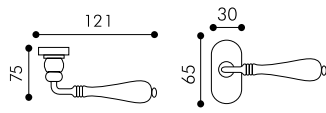
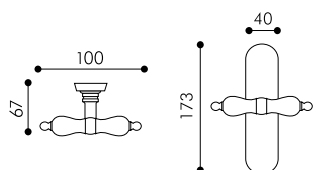

CODICE	DESCRIZIONE	FINITURE	IMBALLO
1820	Guarnitura con molla di ritorno su placche con foro patent o yale. Specificare l'interasse. (vedi pag. 204) Pair spring handles on plate with patent or cylinder hole. Specify the wheelbase (see pag. 204)	OLV OCR CRS OBM	1 1 1 1 
1821	Guarnitura con molla di ritorno su rosette coprivite e bocchette con foro patent o foro yale. Pair spring handles on roses and escutcheons with patent or cylinder hole.	OLV OCR CRS OBM	1 1 1 1 
1822	Maniglia per finestra con movimento DK. Window handle with DK mechanism.	OLV OCR CRS OBM	2 2 2 2 
1823	Martellina o cremonese per finestra su placca. Window handle on plate.	OLV OCR CRS OBM	2 2 2 2 



MERAK





OLV
OTTONE LUCIDO VERNICIATO
POLISHED AND PAINTED BRASS



OCR
CROMO LUCIDO
POLISHED CHROME



CRS
CROMO SATINATO
SATIN CHROME



OBG
BRONZO GRAFFIATO LUCIDO
SCRATCHED POLISHED BRONZE

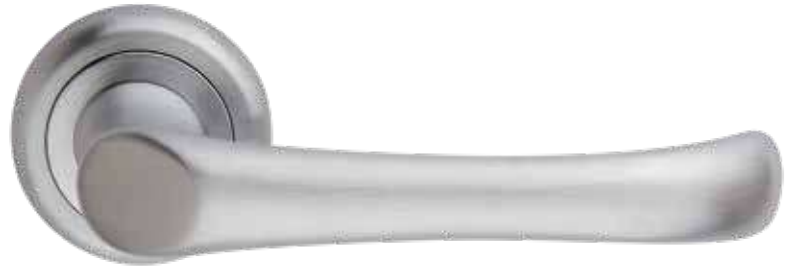

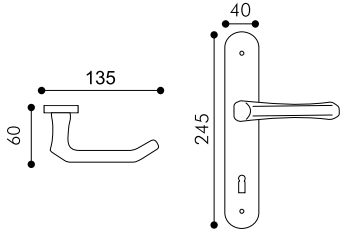
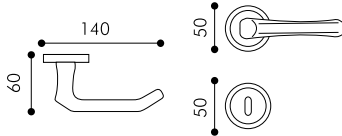
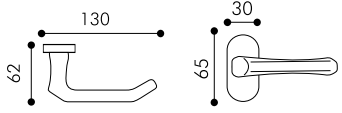
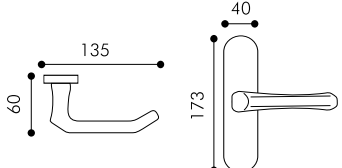
CODICE	DESCRIZIONE	FINITURE	IMBALLO
5010	Guarnitura con molla di ritorno su placche con foro patent o yale. Specificare l'interasse. (vedi pag. 204) Pair spring handles on plate with patent or cylinder hole. Specify the wheelbase (see pag. 204)	OLV OCR CRS OBG	1 1 1 1 
5011	Guarnitura con molla di ritorno su rosette coprivite e bocchette con foro patent o foro yale. Pair spring handles on roses and escutcheons with patent or cylinder hole.	OLV OCR CRS OBG	1 1 1 1 
5012	Maniglia per finestra con movimento DK. Window handle with DK mechanism.	OLV OCR CRS OBG	2 2 2 2 
5014	Martellina o cremonese per finestra con impugnatura a maniglia su placca. Window handle on plate.	OLV OCR CRS OBG	2 2 2 2 



SPIRIT





OLV
OTTONE LUCIDO VERNICIATO
POLISHED AND PAINTED BRASS



CRS
CROMO SATINATO
SATIN CHROME



OLV/OSL
BICOLOR OTTONE LUC./SAT
POLISHED/SATIN BRASS



OCR/CRS
BICOLOR CROMO LUC./SAT
POLISHED/SATIN CHROME

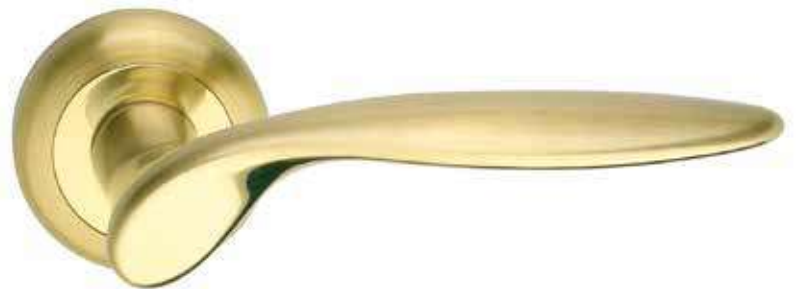

CODICE	DESCRIZIONE	FINITURE	IMBALLO
7030	<p>Guarnitura con molla di ritorno su placche con foro patent o yale. Specificare l'interasse. (vedi pag. 204)</p> <p>Pair spring handles on plate with patent or cylinder hole. Specify the wheelbase (see pag. 204)</p>	<p>OLV 1 CRS 1 OLV/OSL 1 OCR/CRS 1</p>	
7031	<p>Guarnitura con molla di ritorno su rosette coprivite e bocchette con foro patent o foro yale.</p> <p>Pair spring handles on roses and escutcheons with patent or cylinder hole.</p>	<p>OLV 1 CRS 1 OLV/OSL 1 OCR/CRS 1</p>	
7032	<p>Maniglia per finestra con movimento DK. Specificare senso d'apertura. (vedi pag. 205)</p> <p>Window handle with DK mechanism.</p>	<p>OLV 2 CRS 2 OLV/OSL 2 OCR/CRS 2</p>	
7034	<p>Martellina o cremonese per finestra con impugnatura a maniglia su placca.</p> <p>Window handle on plate.</p>	<p>OLV 2 CRS 2 OLV/OSL 2 OCR/CRS 2</p>	



MIZAR





OLV
OTTONE LUCIDO VERNICIATO
POLISHED AND PAINTED BRASS



CRS
CROMO SATINATO
SATIN CHROME



OLV/OSL
BICOLOR OTTONE LUC./SAT
POLISHED/SATIN BRASS



OCR/CRS
BICOLOR CROMO LUC./SAT
POLISHED/SATIN CHROME



CODICE	DESCRIZIONE	FINITURE	IMBALLO	
7040	Guarnitura con molla di ritorno su placche con foro patent o yale. Specificare l'interasse. (vedi pag. 204) Pair spring handles on plate with patent or cylinder hole. Specify the wheelbase (see pag. 204)	OLV CRS OLV/OSL OCR/CRS	1 1 1 1	
7041/C	Guarnitura con molla di ritorno su rosette coprivite e bocchette con foro patent o foro yale. Pair spring handles on roses and escutcheons with patent or cylinder hole.	OLV CRS OLV/OSL OCR/CRS	1 1 1 1	
7042	Maniglia per finestra con movimento DK. Window handle with DK mechanism.	OLV CRS OLV/OSL OCR/CRS	2 2 2 2	
7044	Martellina o cremonese per finestra con impugnatura a maniglia su placca. Window handle on plate.	OLV CRS OLV/OSL OCR/CRS	2 2 2 2	



ALTAIR

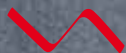



OLV
OTTONE LUCIDO VERNICIATO
POLISHED AND PAINTED BRASS



CRS
CROMO SATINATO
SATIN CHROME



OBM
BRONZO GRAFFIATO OPACO
YESTER BRONZE



CODICE	DESCRIZIONE	FINITURE	IMBALLO	
5030	Guarnitura con molla di ritorno su placche con foro patent o yale. Specificare l'interasse. (vedi pag. 204) Pair spring handles on plate with patent or cylinder hole. Specify the wheelbase (see pag. 204)	OLV CRS OBM	1 1 1	
5031	Guarnitura con molla di ritorno su rosette coprivite e bocchette con foro patent o foro yale. Pair spring handles on roses and escutcheons with patent or cylinder hole.	OLV CRS OBM	1 1 1	
5032	Maniglia per finestra con movimento DK. Window handle with DK mechanism.	OLV CRS OBM	2 2 2	
5034	Martellina o cremonese per finestra con impugnatura a maniglia su placca. Window handle on plate.	OLV CRS OBM	2 2 2	



SOLE

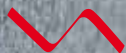



PVD
OTTONE LUCIDO PVD
PVD POLISHED BRASS



OLV
OTTONE LUCIDO VERNICIATO
POLISHED AND PAINTED BRASS



OCR
CROMO LUCIDO
POLISHED CHROME



CRS
CROMO SATINATO
SATIN CHROME



OBM
BRONZO GRAFFIATO OPACO
YESTER BRONZE



CODICE	DESCRIZIONE	FINITURE	IMBALLO
7020	Guarnitura con molla di ritorno su placche con foro patent o yale. Specificare l'interasse. (vedi pag. 204) Pair spring handles on plate with patent or cylinder hole. Specify the wheelbase (see pag. 204)	PVD OLV OCR CRS OBM	1 1 1 1 1
7021	Guarnitura con molla di ritorno su rosette coprivite e bocchette con foro patent o foro yale. Pair spring handles on roses and escutcheons with patent or cylinder hole.	PVD OLV OCR CRS OBM	1 1 1 1 1
7022	Maniglia per finestra con movimento DK. Specificare senso d'apertura. (vedi pag. 205) Window handle with DK mechanism.	PVD OLV OCR CRS OBM	2 2 2 2 2
7024	Martellina o cremonese per finestra con impugnatura a maniglia su placca. Window handle on plate.	PVD OLV OCR CRS OBM	2 2 2 2 2



OMEGA

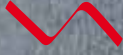



CRS
CROMO SATINATO
SATIN CHROME



OCR/CRS
BICOLOR CROMO LUC/SAT
POLISHED/SATIN CHROME

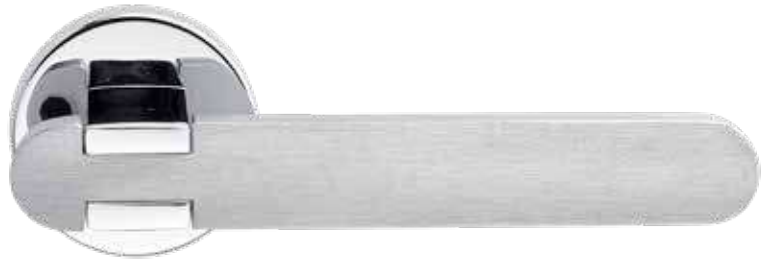

CODICE	DESCRIZIONE	FINITURE	IMBALLO
2801	<p>Guarnitura con molla di ritorno su rosette tonde coprivite e bocchette con foro patent o foro yale.</p> <p>Pair spring handles on round roses and escutcheons with patent or cylinder hole.</p>	<p>CRS</p> <p>OCR/CRS</p>	<p>1</p> <p>1</p>
2801/B	<p>Guarnitura con molla di ritorno su rosette quadre coprivite e bocchette con foro patent o foro yale.</p> <p>Pair spring handles on square roses and escutcheons with patent or cylinder hole.</p>	<p>CRS</p> <p>OCR/CRS</p>	<p>1</p> <p>1</p>
2802	<p>Maniglia per finestra su rosetta ovale con movimento DK.</p> <p>Window handle on oval rose with DK mechanism.</p>	<p>CRS</p> <p>OCR/CRS</p>	<p>2</p> <p>2</p>
2802/B	<p>Maniglia per finestra su rosetta rettangolare con movimento DK.</p> <p>Window handle on rectangular rose with DK mechanism.</p>	<p>CRS</p> <p>OCR/CRS</p>	<p>2</p> <p>2</p>



MIRADUE

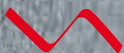



CRS
CROMO SATINATO
SATIN CHROME



OBG
BRONZO GRAFFIATO LUCIDO
SCRATCHED POLISHED BRONZE



NE
NERO
BLACK



CODICE	DESCRIZIONE	FINITURE	IMBALLO
5090	<p>Guarnitura con molla di ritorno su placche con foro patent o yale. Specificare l'interasse. (vedi pag. 204)</p> <p>Pair spring handles on plate with patent or cylinder hole. Specify the wheelbase (see pag. 204)</p>	<p>CRS</p> <p>OBG</p> <p>NE</p>	<p>1</p> <p>1</p> <p>1</p>
5091	<p>Guarnitura con molla di ritorno su rosette coprivite e bocchette con foro patent o foro yale.</p> <p>Pair spring handles on roses and escutcheons with patent or cylinder hole.</p>	<p>CRS</p> <p>OBG</p> <p>NE</p>	<p>1</p> <p>1</p> <p>1</p>
5092	<p>Maniglia per finestra con movimento DK.</p> <p>Window handle with DK mechanism.</p>	<p>CRS</p> <p>OBG</p> <p>NE</p>	<p>2</p> <p>2</p> <p>2</p>



GRETA





OLV
OTTONE LUCIDO VERNICIATO
POLISHED AND PAINTED BRASS



OCR
CROMO LUCIDO
POLISHED CHROME



CRS
CROMO SATINATO
SATIN CHROME



OBG
BRONZO GRAFFIATO LUCIDO
SCRATCHED POLISHED BRONZE

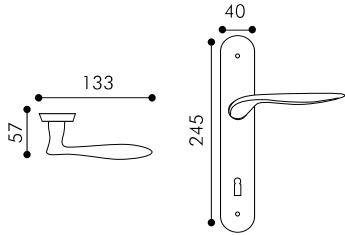
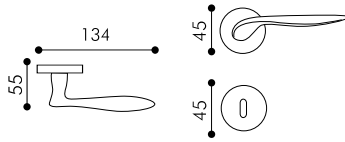
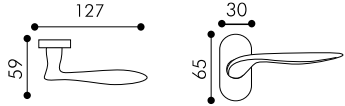
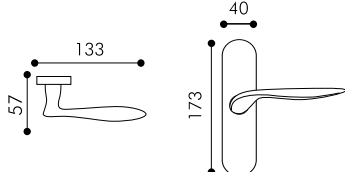

CODICE	DESCRIZIONE	FINITURE	IMBALLO
7080	Guarnitura con molla di ritorno su placche con foro patent o yale. Specificare l'interasse. (vedi pag. 204) Pair spring handles on plate with patent or cylinder hole. Specify the wheelbase (see pag. 204)	OLV OCR CRS OBG	1 1 1 1 
7081	Guarnitura con molla di ritorno su rosette coprivite e bocchette con foro patent o foro yale. Pair spring handles on roses and escutcheons with patent or cylinder hole.	OLV OCR CRS OBG	2 2 2 2 
7082	Maniglia per finestra con movimento DK. Specificare senso d'apertura. (vedi pag. 205) Window handle with DK mechanism.	OLV OCR CRS OBG	4 4 2 2 
7084	Martellina o cremonese per finestra con impugnatura a maniglia su placca. Window handle on plate.	OLV OCR CRS OBG	2 2 2 2 



JOLLY





PVD
OTTONE LUCIDO PVD
PVD POLISHED BRASS



OLV
OTTONE LUCIDO VERNICIATO
POLISHED AND PAINTED BRASS



OCR
CROMO LUCIDO
POLISHED CHROME



CRS
CROMO SATINATO
SATIN CHROME



CODICE	DESCRIZIONE	FINITURE	IMBALLO
8050	Guarnitura con molla di ritorno su placche con foro patent o yale. Specificare l'interasse. (vedi pag. 204) Pair spring handles on plate with patent or cylinder hole. Specify the wheelbase (see pag. 204)	PVD OLV OCR CRS	2 2 2 2
8051	Guarnitura con molla di ritorno su rosette coprivite e bocchette con foro patent o foro yale. Pair spring handles on roses and escutcheons with patent or cylinder hole.	PVD OLV OCR CRS	1 1 1 1
8052	Maniglia per finestra con movimento DK. Window handle with DK mechanism.	PVD OLV OCR CRS	2 2 2 2
8054	Martellina o cremonese per finestra con impugnatura a maniglia su placca. Window handle on plate.	PVD OLV OCR CRS	2 2 2 2



DOLLY





PVD
OTTONE LUCIDO PVD
PVD POLISHED BRASS



OLV
OTTONE LUCIDO VERNICIATO
POLISHED AND PAINTED BRASS



OCR
CROMO LUCIDO
POLISHED CHROME



CRS
CROMO SATINATO
SATIN CHROME



OSL
OTTONE SATINATO VERNICIATO
SATINED AND PAINTED BRASS



OBG
BRONZO GRAFFIATO LUCIDO
SCRATCHED POLISHED BRONZE

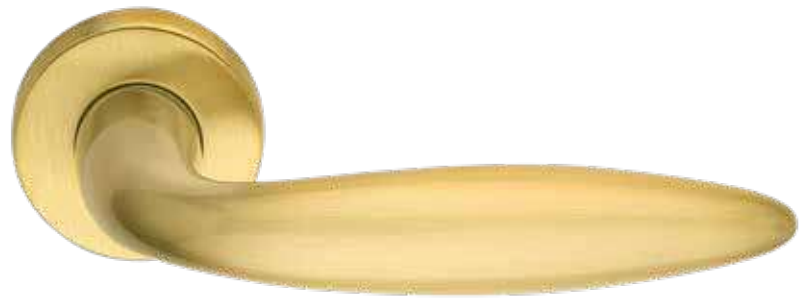

CODICE	DESCRIZIONE	FINITURE	IMBALLO
8040	Guarnitura con molla di ritorno su placche con foro patent o yale. Specificare l'interasse. (vedi pag. 204) Pair spring handles on plate with patent or cylinder hole. Specify the wheelbase (see pag. 204)	PVD	1
		OLV	1
		OCR	1
		CRS	2
		OSL	1
		OBG	2
8041	Guarnitura con molla di ritorno su rosette coprivite e bocchette con foro patent o foro yale. Pair spring handles on roses and escutcheons with patent or cylinder hole.	PVD	1
		OLV	1
		OCR	1
		CRS	1
		OSL	1
		OBG	1
8042	Maniglia per finestra con movimento DK. Window handle with DK mechanism.	PVD	2
		OLV	2
		OCR	2
		CRS	2
		OSL	2
		OBG	2
8044	Martellina o cremonese per finestra con impugnatura a maniglia su placca. Window handle on plate.	PVD	2
		OLV	2
		OCR	2
		CRS	2
		OSL	2
		OBG	2

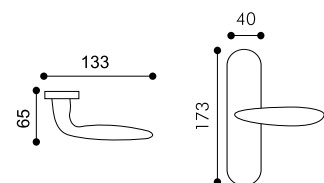
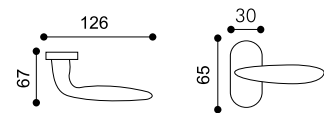
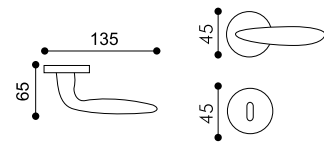
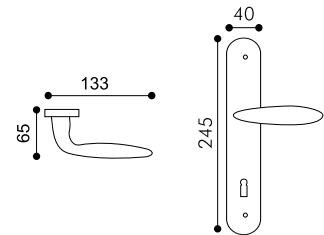

POLAR





ROSETTA DA:
ø 50 mm

OLV/OSL
BICOLOR OTTONE LUC/SAT
POLISHED/SATIN BRASS



OCR/CRS
BICOLOR CROMO LUC/SAT
POLISHED/SATIN CHROME



ROSETTA DA:
ø 45 mm

OLV
OTTONE LUCIDO VERNICIATO
POLISHED AND PAINTED BRASS



CRS
CROMO SATINATO
SATIN CHROME

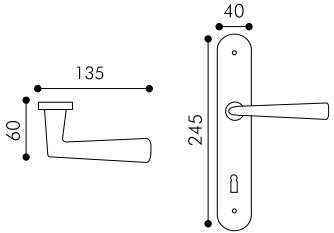
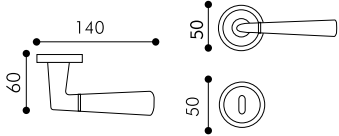
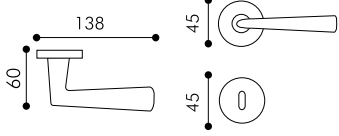
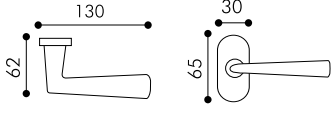
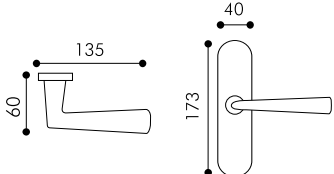

CODICE	DESCRIZIONE	FINITURE	IMBALLO
3000	Guarnitura con molla di ritorno su placche con foro patent o yale. Specificare l'interasse. (vedi pag. 204) Pair spring handles on plate with patent or cylinder hole. Specify the wheelbase (see pag. 204)	OLV CRS OLV/OSL OCR/CRS	1 1 1 1 
3001	Guarnitura con molla di ritorno su rosette coprivite e bocchette con foro patent o foro yale. Pair spring handles on roses and escutcheons with patent or cylinder hole.	OLV/OSL OCR/CRS	1 1 
3011	Guarnitura con molla di ritorno su rosette coprivite e bocchette con foro patent o foro yale. Pair spring handles on roses and escutcheons with patent or cylinder hole.	OLV CRS	1 1 
3002	Maniglia per finestra con movimento DK. Window handle with DK mechanism.	OLV CRS OLV/OSL OCR/CRS	2 2 2 2 
3004	Martellina o cremonese per finestra con impugnatura a maniglia su placca. Window handle on plate.	OLV CRS OLV/OSL OCR/CRS	2 2 2 2 



ARCA





OLV/OSL
BICOLOR OTTONE LUC/SAT
POLISHED/SATIN BRASS

OCR/CRS
BICOLOR CROMO LUC/SAT
POLISHED/SATIN CHROME



CODICE	DESCRIZIONE	FINITURE	IMBALLO
6030	<p>Guarnitura con molla di ritorno su placche con foro patent o yale. Specificare l'interasse. (vedi pag. 204)</p> <p>Pair spring handles on plate with patent or cylinder hole. Specify the wheelbase (see pag. 204)</p>	<p>OLV/OSL</p> <p>OCR/CRS</p>	<p>1</p> <p>1</p>
6031	<p>Guarnitura con molla di ritorno su rosette coprivite e bocchette con foro patent o foro yale.</p> <p>Pair spring handles on roses and escutcheons with patent or cylinder hole.</p>	<p>OLV/OSL</p> <p>OCR/CRS</p>	<p>1</p> <p>1</p>
6032	<p>Maniglia per finestra con movimento DK. Specificare senso d'apertura. (vedi pag. 205)</p> <p>Window handle with DK mechanism.</p>	<p>OLV/OSL</p> <p>OCR/CRS</p>	<p>2</p> <p>2</p>
6034	<p>Martellina o cremonese per finestra con impugnatura a maniglia su placca.</p> <p>Window handle on plate.</p>	<p>OLV/OSL</p> <p>OCR/CRS</p>	<p>2</p> <p>2</p>



CIGNO





OLV/C
 OTTONE LUCIDO VERNICIATO
 PORCELLANA CHIARA
 POLISHED AND PAINTED BRASS
 WHITE CERAMIC



ANT/C
 BRONZO ANTICO OPACO
 PORCELLANA CHIARA
 ANTIQUE BRONZE
 WHITE CERAMIC



CRS/C
 CROMO SATINATO
 PORCELLANA CHIARA
 SATIN CHROME
 WHITE CERAMIC



OBG/S
 BRONZO GRAFFIATO LUCIDO
 PORCELLANA SCURA
 SCRATCHED POLISHED BRONZE
 DARK CERAMIC



OSL/S
 OTTONE SATINATO VERNICIATO
 PORCELLANA SCURA
 SATINED AND PAINTED BRASS
 DARK CERAMIC



CODICE	DESCRIZIONE	FINITURE	IMBALLO
7500	<p>Guarnitura con molla di ritorno su placche con foro patent o yale. Specificare l'interasse. (vedi pag. 204)</p> <p>Pair spring handles on plate with patent or cylinder hole. Specify the wheelbase (see pag. 204)</p>	<p>OLV/C - OLV/S ANT/C - ANT/S CRS/C - CRS/S OBG/C - OBG/S OSL/C - OSL/S</p>	<p>1 1 1 1 1</p>
7501	<p>Guarnitura con molla di ritorno su rosette coprivite e bocchette con foro patent o foro yale.</p> <p>Pair spring handles on roses and escutcheons with patent or cylinder hole.</p>	<p>OLV/C - OLV/S ANT/C - ANT/S CRS/C - CRS/S OBG/C - OBG/S OSL/C - OSL/S</p>	<p>1 1 1 1 1</p>
7502	<p>Maniglia per finestra con movimento DK.</p> <p>Window handle with DK mechanism.</p>	<p>OLV/C - OLV/S ANT/C - ANT/S CRS/C - CRS/S OBG/C - OBG/S OSL/C - OSL/S</p>	<p>2 2 2 2 2</p>
7503	<p>Martellina o cremonese per finestra su placca.</p> <p>Window handle on plate.</p>	<p>OLV/C - OLV/S ANT/C - ANT/S CRS/C - CRS/S OBG/C - OBG/S OSL/C - OSL/S</p>	<p>2 2 2 2 2</p>



OTTONE/PORCELLANA - BRASS/CERAMIC



SCILLA





OLV
 OTTONE LUCIDO VERNICIATO
 PORCELLANA CHIARA
 POLISHED AND PAINTED BRASS
 WHITE CERAMIC



CRS
 CROMO SATINATO
 PORCELLANA CHIARA
 SATIN CHROME
 WHITE CERAMIC



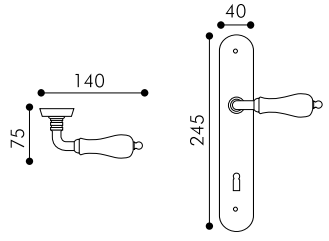
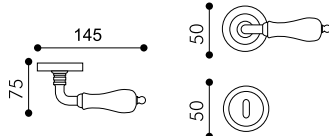
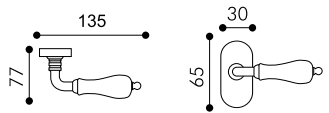
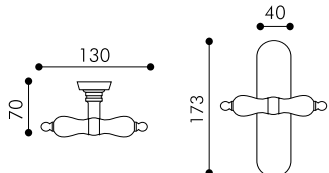

CODICE	DESCRIZIONE	FINITURE	IMBALLO
7400	Guarnitura con molla di ritorno su placche con foro patent o yale. Specify the wheelbase. (vedi pag. 204) Pair spring handles on plate with patent or cylinder hole. Specify the wheelbase (see pag. 204)	OLV CRS	1 1 
7401	Guarnitura con molla di ritorno su rosette coprivite e bocchette con foro patent o foro yale. Pair spring handles on roses and escutcheons with patent or cylinder hole.	OLV CRS	1 1 
7402	Maniglia per finestra con movimento DK. Window handle with DK mechanism.	OLV CRS	2 2 
7403	Martellina o cremonese per finestra su placca. Window handle on plate.	OLV CRS	2 2 



SERIE MINIMAL

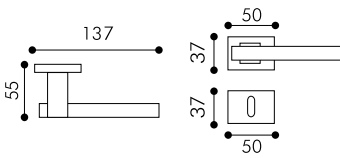

CODICE	DESCRIZIONE	FINITURE	IMBALLO	
41	Guarnitura con molla di ritorno su rosette coprivite e bocchette con foro patent o foro yale. Pair spring handles on roses and escutcheons with patent or cylinder hole.	CRS OCR/CRS	1 1	
BFC/41	Singola bocchetta foro patent. Single escutcheon with patent hole.	CRS OCR	3 3	
BFY/41	Singola bocchetta foro yale. Single escutcheon with cylinder hole.	CRS OCR	3 3	

SERIE MINIMAL



CODICE	DESCRIZIONE	FINITURE	IMBALLO	
51	Guarnitura su rosette minimaliste e bocchette con foro patent. Pair handles on minimal roses and escutcheon with patent hole.	CRS OCR/CRS	1 1	
51/Y	Guarnitura su rosette minimaliste e bocchette con foro yale. Pair handles on minimal roses and escutcheon with cylinder hole.	CRS OCR/CRS	1 1	
BFC/51	Singola bocchetta foro patent. Single escutcheon with patent hole.	CRS OCR	3 3	
BFY/51	Singola bocchetta foro yale. Single escutcheon with cylinder hole.	CRS OCR	3 3	

YORK MINI

LEGA 6060 - ALUMINUM 6060



SERIE MINIMAL



CODICE	DESCRIZIONE	FINITURE	IMBALLO
61	Guarnitura su rosette minimaliste e bocchette con foro patent. Pair handles on minimal roses and escutcheon with patent hole.	ECRS CRS NE	1 1 1
61/Y	Guarnitura su rosette minimaliste e bocchette con foro yale. Pair handles on minimal roses and escutcheon with cylinder hole.	ECRS CRS NE	1 1 1
BFC/51	Singola bocchetta foro patent. Single escutcheon with patent hole.	CRS NE	3 3
BFY/51	Singola bocchetta foro yale. Single escutcheon with cylinder hole.	CRS NE	3 3

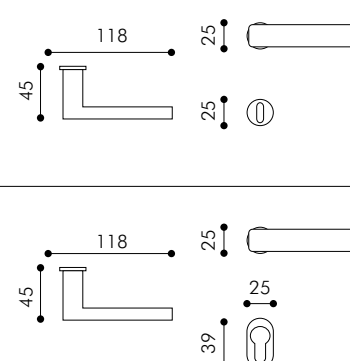

ZAMA - ZAMAK : "CRS"
ALLUMINIO - ALUMINUM : "ECRS" "NE"

PIC MINI



SERIE MINIMAL



CODICE	DESCRIZIONE	FINITURE	IMBALLO
71	Guarnitura su rosette minimaliste e bocchette con foro patent. Pair handles on minimal roses and escutcheon with patent hole.	CRS OCR	1 1
71/Y	Guarnitura su rosette minimaliste e bocchette con foro yale. Pair handles on minimal roses and escutcheon with cylinder hole.	CRS OCR	1 1
BFC/51	Singola bocchetta foro patent. Single escutcheon with patent hole.	CRS OCR	3 3
BFY/51	Singola bocchetta foro yale. Single escutcheon with cylinder hole.	CRS OCR	3 3

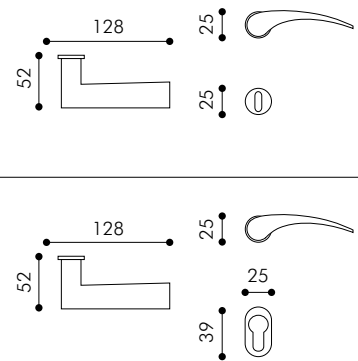

PRIMA MINI

OTTONE - BRASS



SERIE BASIC





CRS
CROMO SATINATO
SATIN CHROME



ECRS
EFFETTO CROMO SATINATO
SATIN CHROME EFFECT



SIL
EFFETTO NIKEL SATINATO
SATIN NIKEL EFFECT



ATR
EFFETTO ANTRACITE
ANTHRACITE



NE
NERO
BLACK



CODICE	DESCRIZIONE	FINITURE	IMBALLO	
3601	Guarnitura con molla di ritorno su rosette coprivite e bocchette con foro patent o foro yale. Pair spring handles on roses and escutcheons with patent or cylinder hole.	CRS ECRS SIL ATR NE	1 1 1 1 1	
3602	Maniglia per finestra con movimento DK. Window handle with DK mechanism.	CRS ECRS SIL ATR NE	1 1 1 1 1	



ZAMA - ZAMAK : "CRS"
ALUMINIO - ALUMINUM : "ECRS" "SIL" "ATR" "NE"



CRS
CROMO SATINATO
SATIN CHROME



ECRS
EFFETTO CROMO SATINATO
SATIN CHROME EFFECT



SIL
EFFETTO NIKEL SATINATO
SATIN NIKEL EFFECT



ATR
EFFETTO ANTRACITE
ANTHRACITE



NE
NERO
BLACK



CODICE	DESCRIZIONE	FINITURE	IMBALLO
3501	Guarnitura con molla di ritorno su rosette coprivite e bocchette con foro patent o foro yale. Pair spring handles on roses and escutcheons with patent or cylinder hole.	CRS	1
		ECRS	1
		SIL	1
		ATR	1
		NE	1
3502	Maniglia per finestra con movimento DK. Window handle with DK mechanism.	CRS	1
		ECRS	1
		SIL	1
		ATR	1
		NE	1

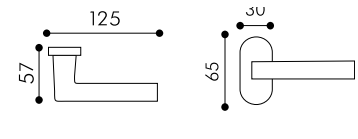
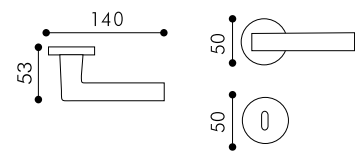



CRS
CROMO SATINATO
SATIN CHROME



ECRS
EFFETTO CROMO SATINATO
SATIN CHROME EFFECT



SIL
EFFETTO NIKEL SATINATO
SATIN NIKEL EFFECT



ATR
EFFETTO ANTRACITE
ANTHRACITE



NE
NERO
BLACK



CODICE	DESCRIZIONE	FINITURE	IMBALLO
--------	-------------	----------	---------

3701

Guarnitura con molla di ritorno su rosette coprivite e bocchette con foro patent o foro yale.

Pair spring handles on roses and escutcheons with patent or cylinder hole.

CRS	1
ECRS	1
SIL	1
ATR	1
NE	1

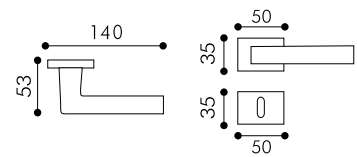

3702

Maniglia per finestra con movimento DK.

Window handle with DK mechanism.

CRS	1
ECRS	1
SIL	1
ATR	1
NE	1

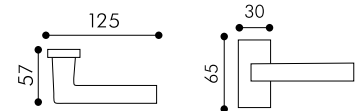

CAPRI

ZAMA - ZAMAK : "CRS"

ALLUMINIO - ALUMINUM : "ECRS" "SIL" "ATR" "NE"

BASIC



OCR
CROMO LUCIDO
POLISHED CHROME

CRS
CROMO SATINATO
SATIN CHROME

OCR/CRS
BICOLOR CROMO LUC/SAT
POLISHED/SATIN CHROME

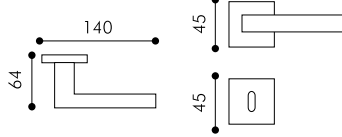
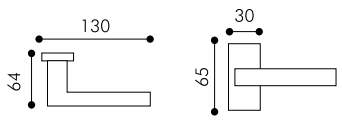
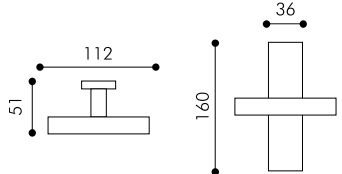

CODICE	DESCRIZIONE	FINITURE	IMBALLO
9097	<p>Guarnitura con molla di ritorno su rosette coprivite e bocchette con foro patent o foro yale.</p> <p>Pair spring handles on roses and escutcheons with patent or cylinder hole.</p>	<p>OCR</p> <p>CRS</p> <p>OCR/CRS</p>	<p>1</p> <p>1</p> <p>1</p> 
9098	<p>Maniglia per finestra con movimento DK.</p> <p>Window handle with DK mechanism.</p>	<p>OCR</p> <p>CRS</p> <p>OCR/CRS</p>	<p>1</p> <p>1</p> <p>1</p> 
9093	<p>Martellina o cremonese per finestra su placca.</p> <p>Window handle on plate.</p>	<p>OCR</p> <p>CRS</p>	<p>2</p> <p>2</p> 



CRS
CROMO SATINATO
SATIN CHROME



NE
NERO
BLACK



BNC
BIANCO
WHITE

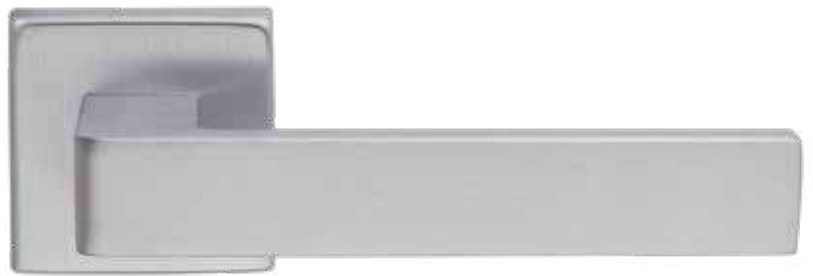

CODICE	DESCRIZIONE	FINITURE	IMBALLO	
8091/ALL	Guarnitura con molla di ritorno su rosette coprivite e bocchette con foro patent o foro yale. Pair spring handles on roses and escutcheons with patent or cylinder hole.	CRS NE BNC	1 1 1	
8091/R/ALL	Guarnitura con molla di ritorno su rosette rettangolari e bocchette con foro patent o foro yale. Pair spring handles on rectangular roses and escutcheons with patent or cylinder hole.	CRS NE BNC	1 1 1	
8092/ALL	Maniglia per finestra con movimento DK. Window handle with DK mechanism.	CRS NE BNC	2 2 2	



CRS
CROMO SATINATO
SATIN CHROME



CODICE	DESCRIZIONE	FINITURE	IMBALLO	
6081/BP/45	<p>Guarnitura con molla di ritorno su rosetta alluminio coprivite e bocchette con foro patent o foro yale.</p> <p>Pair spring handles on roses and escutcheons with patent or cylinder hole.</p>	CRS	1	
6082/BP	<p>Maniglia per finestra con movimento DK.</p> <p>Window handle with DK mechanism.</p>	CRS	1	



OCR
CROMO LUCIDO
POLISHED CHROME

CRS
CROMO SATINATO
SATIN CHROME

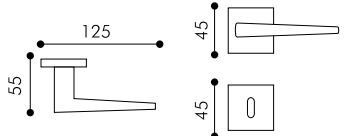
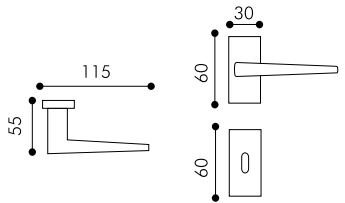
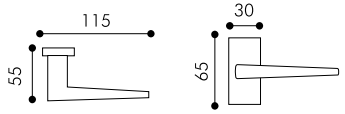
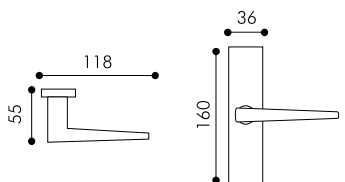

CODICE	DESCRIZIONE	FINITURE	IMBALLO
9071	Guarnitura con molla di ritorno su rosette coprivite e bocchette con foro patent o foro yale. Pair spring handles on roses and escutcheons with patent or cylinder hole.	OCR CRS	1 1 
9071/R	Guarnitura con molla di ritorno su rosette rettangolari e bocchette con foro patent o foro yale. Pair spring handles on rectangular roses and escutcheons with patent or cylinder hole.	OCR CRS	1 1 
9072	Maniglia per finestra con movimento DK. Window handle with DK mechanism.	OCR CRS	2 2 
9074	Martellina o cremonese per finestra con impugnatura a maniglia su placca. Window handle on plate.	OCR CRS	2 2 



CRS
CROMO SATINATO
SATIN CHROME

NE
NERO
BLACK

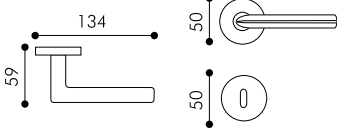
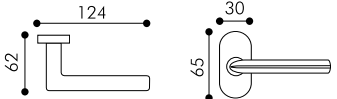

CODICE	DESCRIZIONE	FINITURE	IMBALLO
171	<p>Guarnitura con molla di ritorno su rosetta alluminio coprivite e bocchette con foro patent o foro yale.</p> <p>Pair spring handles on roses and escutcheons with patent or cylinder hole.</p>	<p>CRS</p> <p>NE</p>	<p>1</p> <p>1</p> 
172	<p>Maniglia per finestra con movimento DK.</p> <p>Window handle with DK mechanism.</p>	<p>CRS</p> <p>NE</p>	<p>2</p> <p>2</p> 



OLV
OTTONE LUCIDO VERNICIATO
POLISHED AND PAINTED BRASS



OCR
CROMO LUCIDO
POLISHED CHROME



CRS
CROMO SATINATO
SATIN CHROME



NKS
NIKEL SATINATO
SATIN NIKEL



OBG
BRONZO GRAFFIATO LUCIDO
SCRATCHED POLISHED BRONZE



CODICE	DESCRIZIONE	FINITURE	IMBALLO	
5020	Guarnitura con molla di ritorno su placche con foro patent o yale. Specificare l'interasse. (vedi pag. 204) Pair spring handles on plate with patent or cylinder hole. Specify the wheelbase (see pag. 204)	OLV OCR CRS NKS OBG	1 1 1 1 1	
5021	Guarnitura con molla di ritorno su rosette coprivite e bocchette con foro patent o foro yale. Pair spring handles on roses and escutcheons with patent or cylinder hole.	OLV OCR CRS NKS OBG	1 1 1 1 1	
5022	Maniglia per finestra con movimento DK. Window handle with DK mechanism.	OLV OCR CRS NKS OBG	2 2 2 2 2	
5023	Martellina o cremonese per finestra su placca meccanismo intercambiabile . Window handle on plate.	OLV OCR CRS NKS OBG	2 2 2 2 2	



OLV
OTTONE LUCIDO VERNICIATO
POLISHED AND PAINTED BRASS

CRS
CROMO SATINATO
SATIN CHROME

OVI
OTTONE NATURALE OPACO
NATURAL MATT BRASS

OSL
OTTONE SATINATO VERNICIATO
SATINED AND PAINTED BRASS

OBG
BRONZO GRAFFIATO LUCIDO
SCRATCHED POLISHED BRONZE

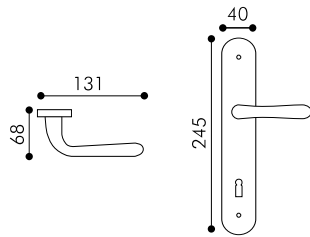
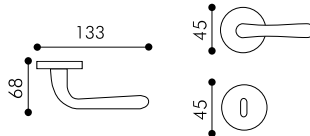
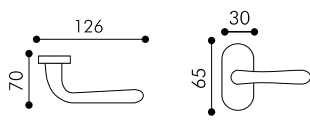
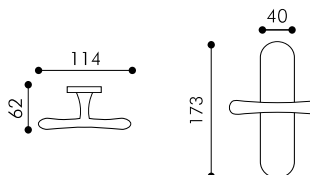

CODICE	DESCRIZIONE	FINITURE	IMBALLO	
5080	<p>Guarnitura con molla di ritorno su placche con foro patent o yale. Specificare l'interasse. (vedi pag. 204)</p> <p>Pair spring handles on plate with patent or cylinder hole. Specify the wheelbase (see pag. 204)</p>	<p>OLV</p> <p>CRS</p> <p>OVI</p> <p>OSL</p> <p>OBG</p>	<p>1</p> <p>1</p> <p>1</p> <p>1</p> <p>1</p>	
5081	<p>Guarnitura con molla di ritorno su rosette coprivite e bocchette con foro patent o foro yale.</p> <p>Pair spring handles on roses and escutcheons with patent or cylinder hole.</p>	<p>OLV</p> <p>CRS</p> <p>OVI</p> <p>OSL</p> <p>OBG</p>	<p>1</p> <p>1</p> <p>1</p> <p>1</p> <p>1</p>	
5082	<p>Maniglia per finestra con movimento DK.</p> <p>Window handle with DK mechanism.</p>	<p>OLV</p> <p>CRS</p> <p>OVI</p> <p>OSL</p> <p>OBG</p>	<p>2</p> <p>2</p> <p>2</p> <p>2</p> <p>2</p>	
5083	<p>Martellina o cremonese per finestra su placca meccanismo intercambiabile.</p> <p>Window handle on plate.</p>	<p>OLV</p> <p>CRS</p> <p>OVI</p> <p>OSL</p> <p>OBG</p>	<p>2</p> <p>2</p> <p>2</p> <p>2</p> <p>2</p>	



OLV
OTTONE LUCIDO VERNICIATO
POLISHED AND PAINTED BRASS



OCR
CROMO LUCIDO
POLISHED CHROME



CRS
CROMO SATINATO
SATIN CHROME



OBG
BRONZO GRAFFIATO LUCIDO
SCRATCHED POLISHED BRONZE



CODICE	DESCRIZIONE	FINITURE	IMBALLO
5080/Z	<p>Guarnitura con molla di ritorno su placche con foro patent o yale. Specificare l'interasse. (vedi pag. 204)</p> <p>Pair spring handles on plate with patent or cylinder hole. Specify the wheelbase (see pag. 204)</p>	<p>OLV</p> <p>OCR</p> <p>CRS</p> <p>OBG</p>	<p>1</p> <p>1</p> <p>1</p> <p>1</p>
5081/Z	<p>Guarnitura con molla di ritorno su rosette coprivite e bocchette con foro patent o foro yale.</p> <p>Pair spring handles on roses and escutcheons with patent or cylinder hole.</p>	<p>OLV</p> <p>OCR</p> <p>CRS</p> <p>OBG</p>	<p>1</p> <p>1</p> <p>1</p> <p>1</p>
5082/Z	<p>Maniglia per finestra con movimento DK.</p> <p>Window handle with DK mechanism.</p>	<p>OLV</p> <p>OCR</p> <p>CRS</p> <p>OBG</p>	<p>2</p> <p>2</p> <p>2</p> <p>2</p>



OLV
OTTONE LUCIDO VERNICIATO
POLISHED AND PAINTED BRASS

OCR
CROMO LUCIDO
POLISHED CHROME

CRS
CROMO SATINATO
SATIN CHROME

NKS
NIKEL SATINATO
SATIN NIKEL

OSL
OTTONE SATINATO VERNICIATO
SATINED AND PAINTED BRASS

OBG
BRONZO GRAFFIATO LUCIDO
SCRATCHED POLISHED BRONZE

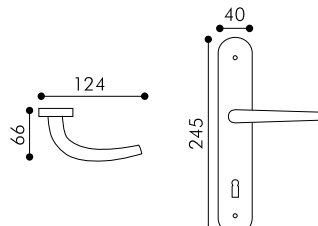
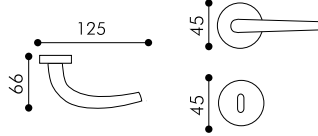
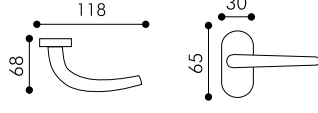
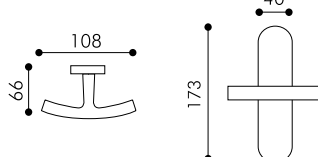

CODICE	DESCRIZIONE	FINITURE	IMBALLO
5040	<p>Guarnitura con molla di ritorno su placche con foro patent o yale. Specificare l'interasse. (vedi pag. 204)</p> <p>Pair spring handles on plate with patent or cylinder hole. Specify the wheelbase (see pag. 204)</p>	<p>OLV OCR CRS NKS OSL OBG</p>	<p>1 1 1 1 1 1</p> 
5041	<p>Guarnitura con molla di ritorno su rosette coprivite e bocchette con foro patent o foro yale.</p> <p>Pair spring handles on roses and escutcheons with patent or cylinder hole.</p>	<p>OLV OCR CRS NKS OSL OBG</p>	<p>1 1 1 1 1 1</p> 
5042	<p>Maniglia per finestra con movimento DK.</p> <p>Window handle with DK mechanism.</p>	<p>OLV OCR CRS NKS OSL OBG</p>	<p>2 2 2 2 2 2</p> 
5043	<p>Martellina o cremonese per finestra su placca meccanismo intercambiabile.</p> <p>Window handle on plate.</p>	<p>OLV OCR CRS NKS OSL OBG</p>	<p>2 2 2 2 2 2</p> 



OLV
OTTONE LUCIDO VERNICIATO
POLISHED AND PAINTED BRASS



CRS
CROMO SATINATO
SATIN CHROME



OBG
BRONZO GRAFFIATO LUCIDO
SCRATCHED POLISHED BRONZE



CODICE	DESCRIZIONE	FINITURE	IMBALLO
2100	<p>Guarnitura con molla di ritorno su placche con foro patent o yale. Specificare l'interasse. (vedi pag. 204)</p> <p>Pair spring handles on plate with patent or cylinder hole. Specify the wheelbase (see pag. 204)</p>	<p>OLV</p> <p>CRS</p> <p>OBG</p>	<p>1</p> <p>1</p> <p>1</p>
2101	<p>Guarnitura con molla di ritorno su rosette coprivite e bocchette con foro patent o foro yale.</p> <p>Pair spring handles on roses and escutcheons with patent or cylinder hole.</p>	<p>OLV</p> <p>CRS</p> <p>OBG</p>	<p>1</p> <p>1</p> <p>1</p>
2102	<p>Maniglia per finestra con movimento DK. Specificare senso d'apertura. (vedi pag. 205)</p> <p>Window handle with DK mechanism.</p>	<p>OLV</p> <p>CRS</p> <p>OBG</p>	<p>2</p> <p>2</p> <p>2</p>



OLV
OTTONE LUCIDO VERNICIATO
POLISHED AND PAINTED BRASS

OCR
CROMO LUCIDO
POLISHED CHROME

CRS
CROMO SATINATO
SATIN CHROME

OBG
BRONZO GRAFFIATO LUCIDO
SCRATCHED POLISHED BRONZE



CODICE	DESCRIZIONE	FINITURE	IMBALLO	
6020	Guarnitura con molla di ritorno su placche con foro patent o yale. Specificare l'interasse. (vedi pag. 204) Pair spring handles on plate with patent or cylinder hole. Specify the wheelbase (see pag. 204)	OLV OCR CRS OBG	1 1 1 1	
6021	Guarnitura con molla di ritorno su rosette coprivite e bocchette con foro patent o foro yale. Pair spring handles on roses and escutcheons with patent or cylinder hole.	OLV OCR CRS OBG	1 1 1 1	
6022	Maniglia per finestra con movimento DK. Window handle with DK mechanism.	OLV OCR CRS OBG	2 2 2 2	
6023	Martellina o cremonese per finestra su placca meccanismo intercambiabile. Window handle on plate.	OLV OCR CRS OBG	2 2 2 2	
6023/F	Martellina o cremonese per finestra su placca con viti a vista monoblocco. Window handle on plate with screw holes.	OLV OCR CRS OBG	2 2 2 2	



OLV
OTTONE LUCIDO VERNICIATO
POLISHED AND PAINTED BRASS



CRS
CROMO SATINATO
SATIN CHROME



OBG
BRONZO GRAFFIATO LUCIDO
SCRATCHED POLISHED BRONZE



CODICE	DESCRIZIONE	FINITURE	IMBALLO	
6010	Guarnitura con molla di ritorno su placche con foro patent o yale. Specificare l'interasse. (vedi pag. 204) Pair spring handles on plate with patent or cylinder hole. Specify the wheelbase (see pag. 204)	OLV CRS OBG	1 1 1	
6011	Guarnitura con molla di ritorno su rosette coprivite e bocchette con foro patent o foro yale. Pair spring handles on roses and escutcheons with patent or cylinder hole.	OLV CRS OBG	1 1 1	
6012	Maniglia per finestra con movimento DK. Specificare senso d'apertura. (vedi pag. 205) Window handle with DK mechanism.	OLV CRS OBG	2 2 2	
6014	Martellina o cremonese per finestra con impugnatura a maniglia su placca. Window handle on plate.	OLV CRS OBG	2 2 2	

MANIGLIONI



SERIE B-52



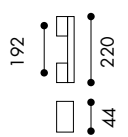
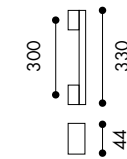
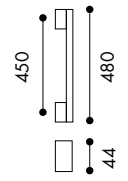
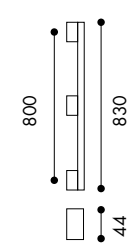

CODICE	DESCRIZIONE FINITURE	IMBALLO
991/220 991/330  	Maniglione B-52 Single pull handle B-52 lunghezza 220 mm - interasse 192 mm length 220 mm - wheelbase 192 mm CROMO SATINATO "CRS" EFFETTO CROMO SATINATO "ECRS" NERO "NE"	1 1 1
991/480 991/830  	lunghezza 480 mm - interasse 450 mm length 480 mm - wheelbase 450 mm CROMO SATINATO "CRS" EFFETTO CROMO SATINATO "ECRS" NERO "NE"	1 1 1
	lunghezza 830 mm - interasse 800 mm - 3 punti di fissaggio length 830 mm - wheelbase 800 mm CROMO SATINATO "CRS" EFFETTO CROMO SATINATO "ECRS" NERO "NE"	1 1 1

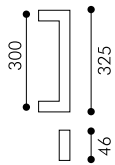

ZAMA/LEGA6060 - ZAMAK/ALUMINUM 6060

PULL HANDLES

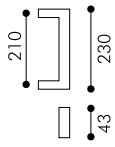
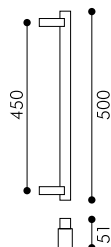
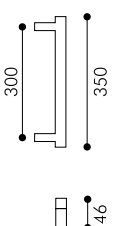
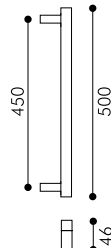
CODICE	DESCRIZIONE FINITURE	IMBALLO
9350	Maniglione Quadra Single pull handle Quadra	LEGA 6060
	lunghezza 325 mm - interasse 300 mm length 325 mm - wheelbase 300 mm	
	CROMO SATINATO "CRS"	1
	NERO "NE"	1
	BIANCO "BNC"	1
		
9067	Maniglione Quadra Sport alluminio Single pull handle Quadra Sport aluminum	LEGA 6060
	lunghezza 230 mm - interasse 210 mm length 230 mm - wheelbase 210 mm	
	CROMO SATINATO "CRS"	1
	NERO "NE"	1
	BIANCO "BNC"	1
		
9059	9059/500 Maniglione Sirio Single pull handle Sirio	OTTONE / BRASS
	lunghezza 330 mm - interasse 300 mm length 330 mm - wheelbase 300 mm	
		
	CROMO SATINATO "CRS"	1
	BICOLOR CROMO LUC/SAT "OCR/CRS"	1
		
9039/350	9039/500 Maniglione Q-Cinque Single pull handle Q-Cinque	LEGA 6060
	lunghezza 350 mm - interasse 300 mm length 350 mm - wheelbase 300 mm	
		
	EFFETTO CROMO SATINATO "ECSR"	1
	NERO "NE"	1
	BIANCO "BNC"	1
		
	lunghezza 500 mm - interasse 450 mm length 500 mm - wheelbase 450 mm	
	EFFETTO CROMO SATINATO "ECSR"	1
	NERO "NE"	1
	BIANCO "BNC"	1



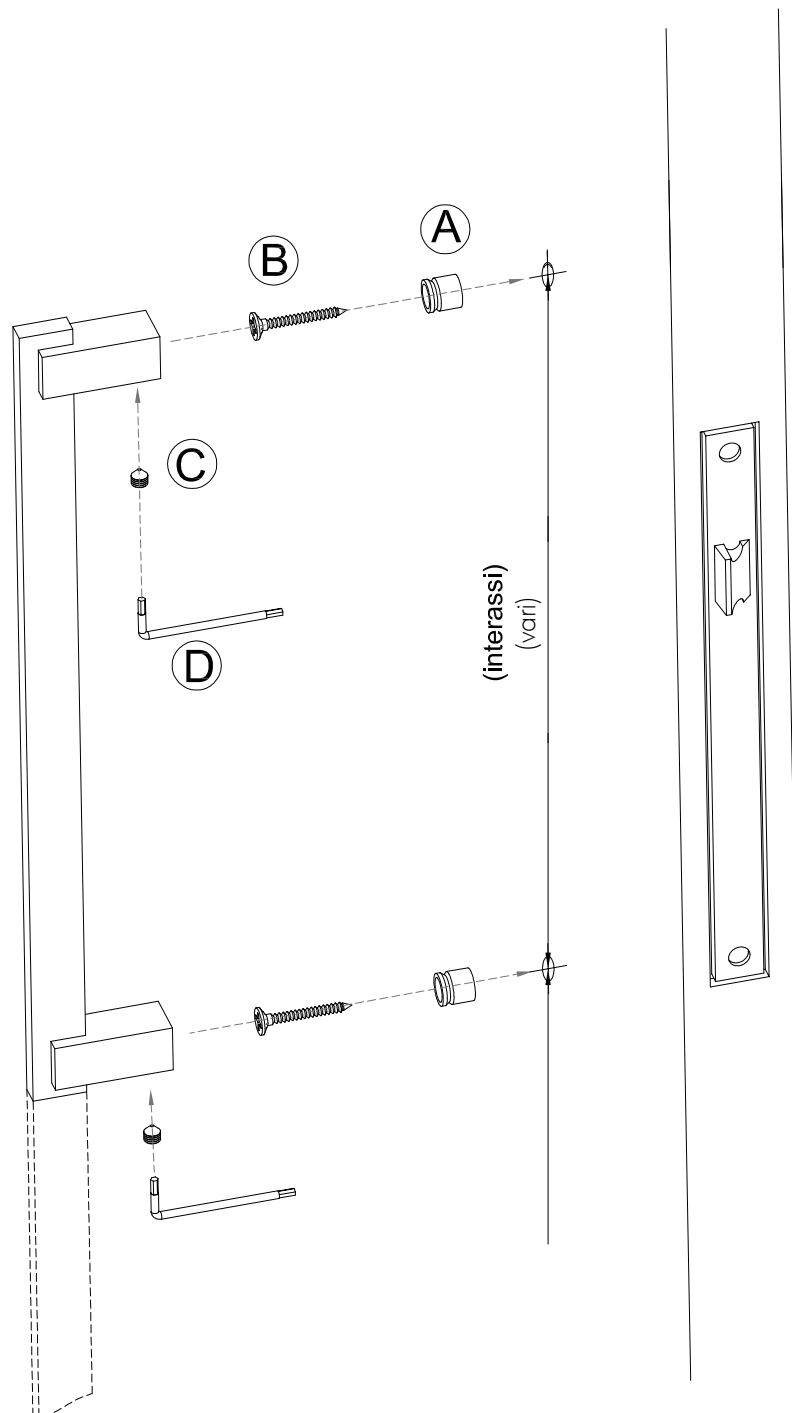

MANIGLIONI

PULL HANDLES

SCHEMA DI MONTAGGIO MANIGLIONI SENZA ROSETTE







- 1) fissare LE BUSSOLE (A) mediante le VITI AUTOFILETTANTI (B) all'interasse del maniglione da montare.
- 2) inserire il MANIGLIONE sulle bussoline (A).
- 3) fissare il MANIGLIONE serrando i GRANI (C), utilizzando la CHIAVE (D).

CODICE	DESCRIZIONE	FINITURE	IMBALLO
771	<p>Maniglione Lusso Pesante senza rosette</p> <p>Single pull handle heavy lux without roses</p>	<p>lunghezza 280 mm - interasse 250 mm length 280 mm - wheelbase 250 mm</p> <p>OTTONE LUCIDO VERNICIATO "OLV" CROMO LUCIDO "OCR" CROMO SATINATO "CRS" BRONZO GRAFFIATO LUCIDO "OBG"</p>	<p>OTTONE / BRASS</p> <p>1 1 1 1</p> 
770/E	<p>Maniglione Aba rosette a pressione ø 45 mm</p> <p>Single pull handle Aba roses ø 45</p>	<p>lunghezza 250 mm - interasse 200 mm length 250 mm - wheelbase 200 mm</p> <p>OTTONE LUCIDO PVD "PVD" OTTONE LUCIDO VERNICIATO "OLV" CROMO LUCIDO "OCR" CROMO SATINATO "CRS" BRONZO GRAFFIATO LUCIDO "OBG"</p>	<p>OTTONE / BRASS</p> <p>1 1 1 1 1</p> 
980	<p>Maniglione Sliding zancato senza rosette</p> <p>Single pull handle Sliding decentralized without roses</p>	<p>lunghezza 225 mm - interasse 200 mm length 225 mm - wheelbase 200 mm</p> <p>OTTONE LUCIDO PVD "PVD" OTTONE LUCIDO VERNICIATO "OLV" CROMO SATINATO "CRS" BRONZO GRAFFIATO LUCIDO "OBG"</p>	<p>OTTONE / BRASS</p> <p>1 1 1 1</p> 
970	<p>Maniglione Sliding diritto senza rosette</p> <p>Single pull handle Sliding straight without roses</p>	<p>lunghezza 225 mm - interasse 200 mm length 225 mm - wheelbase 200 mm</p> <p>OTTONE LUCIDO VERNICIATO "OLV" CROMO SATINATO "CRS" BRONZO GRAFFIATO LUCIDO "OBG"</p>	<p>OTTONE / BRASS</p> <p>1 1 1</p> 

MANIGLIONI



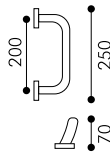
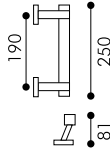
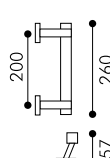
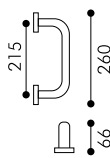

PULL HANDLES

CODICE	DESCRIZIONE	FINITURE	IMBALLO
940/E	<p>Maniglione Stile rosette ø 45 mm</p> <p>Single pull handle Stile roses ø 45</p>	<p>lunghezza 260 mm - interasse 215 mm length 260 mm - wheelbase 215 mm</p> <p>OTTONE LUCIDO PVD "PVD" 1 OTTONE LUCIDO VERNICIATO "OLV" 1 CROMO LUCIDO "OCR" 1 CROMO SATINATO "CRS" 1 BRONZO GRAFFIATO LUCIDO "OBG" 1</p>	<p>OTTONE / BRASS</p> 
950	<p>Maniglione Urano base appoggio 35x35 mm</p> <p>Single pull handle Urano base 35x35 mm</p>	<p>lunghezza 260 mm - interasse 200 mm length 260 mm - wheelbase 200 mm</p> <p>OTTONE LUCIDO VERNICIATO "OLV" 1 OTTONE LUCIDO NON VERNICIATO "OLN" 1 BRONZO GRAFFIATO LUCIDO "OBG" 1</p>	<p>OTTONE / BRASS</p> 
992	<p>Maniglione Margherita rosette ø 55 mm</p> <p>Single pull handle Margherita roses ø 55 mm</p>	<p>lunghezza 250 mm - interasse 190 mm length 250 mm - wheelbase 190 mm</p> <p>OTTONE LUCIDO PVD "PVD" 1 OTTONE LUCIDO VERNICIATO "OLV" 1 CROMO SATINATO "CRS" 1 BRONZO GRAFFIATO LUCIDO "OBG" 1</p>	<p>OTTONE / BRASS</p> 
770	<p>Maniglione Aba rosette a vitare ø 50</p> <p>Single pull handle Aba roses ø 50</p>	<p>lunghezza 250 mm - interasse 200 mm length 250 mm - wheelbase 200 mm</p> <p>OTTONE LUCIDO PVD "PVD" 1 OTTONE LUCIDO VERNICIATO "OLV" 1 CROMO LUCIDO "OCR" 1 CROMO SATINATO "CRS" 1 BRONZO GRAFFIATO LUCIDO "OBG" 1</p>	<p>OTTONE / BRASS</p> 

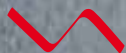

POMOLI E COORDINATI



CODICE	DESCRIZIONE	FINITURE	IMBALLO	
151	Coppia pomolo Idra rosette ø 45 mm con bocchette yale o patent. Pair knobs Idra roses ø 45 mm with escutcheons with patent or cylinder hole.	OTTONE LUCIDO PVD "PVD" OTTONE LUCIDO VERNICIATO "OLV" OTTONE SATINATO VERNICIATO "OSL" CROMO LUCIDO "OCR" CROMO SATINATO "CRS" BRONZO GRAFFIATO LUCIDO "OBG" NIKEL SATINATO "NKS"	1 1 1 1 1 1 1	OTTONE / BRASS 
151/C	Coppia pomolo Idra rosette ø 50 mm ad avvitare con bocchette yale o patent. Pair knobs Idra roses ø 50 mm with escutcheons with patent or cylinder hole.	OTTONE LUCIDO VERNICIATO "OLV" OTTONE SATINATO VERNICIATO "OSL" CROMO LUCIDO "OCR" CROMO SATINATO "CRS" BRONZO GRAFFIATO LUCIDO "OBG" NIKEL SATINATO "NKS"	1 1 1 1 1 1	OTTONE / BRASS 
171/C	Coppia pomolo Delta rosette ø 50 mm ad avvitare con bocchette yale o patent. Pair knobs Idra roses ø 50 mm with escutcheons with patent or cylinder hole.	OTTONE LUCIDO VERNICIATO "OLV" CROMO SATINATO "CRS" BRONZO GRAFFIATO LUCIDO "OBG"	1 1 1	OTTONE / BRASS 
808	Coppia pomolo Blog ø 55 mm gambo centrale rosette ø 50 mm con bocchette yale o patent. Pair knobs Blog ø 55 mm roses ø 50 mm with escutcheons with patent or cylinder hole.	CROMO SATINATO "CRS" NERO "NE"	1 1	ZAMA / ZAMAK 
808/D	Coppia pomolo Blog ø 55 mm decentrato rosette ø 50 mm con bocchette yale o patent. Pair knobs Blog ø 55 mm roses ø 50 mm with escutcheons with patent or cylinder hole.	CROMO SATINATO "CRS" NERO "NE"	1 1	ZAMA / ZAMAK 

COPPIA
POMOLI



PAIR KNOBS

CODICE	DESCRIZIONE	FINITURE	IMBALLO
117/C	Coppia pomolo Atene rosette ø 50 mm ad avvitare con bocchette yale o patent. Pair knobs Atene roses ø 50 mm with escutcheons with patent or cylinder hole.	OTTONE LUCIDO VERNICIATO "OLV" CROMO SATINATO "CRS" OTTONE FERRO ANTICO "NA"	1 1 1 OTTONE / BRASS 
102/C	Coppia pomolo Victoria rosette ø 50 mm ad avvitare con bocchette yale o patent. Pair knobs Victoria roses ø 50 mm with escutcheons with patent or cylinder hole.	OTTONE LUCIDO VERNICIATO "OLV" CROMO LUCIDO "OCR" CROMO SATINATO "CRS" BRONZO GRAFFIATO LUCIDO "OBG" NIKEL SATINATO "NKS"	1 1 1 1 1 OTTONE / BRASS 
108	Coppia pomolo Cigno rosette ø 50 mm ad avvitare con bocchette yale o patent. Pair knobs Cigno roses ø 50 mm with escutcheons with patent or cylinder hole.	Porcellana chiara White ceramic OTTONE LUCIDO VERNICIATO "OLV" BRONZO ANTICO OPACO "ANT" Porcellana scura Dark ceramic OTTONE LUCIDO VERNICIATO "OLV" BRONZO ANTICO OPACO "ANT"	1 1 1 1 OTTONE / BRASS 
908	Coppia pomolo Quadro 60x 60 mm gambo centrale rosette 50x50 mm con bocchette yale o patent. Pair squared knobs 60x60 mm roses 50x50 mm with escutcheons with patent or cylinder hole.	CROMO LUCIDO "OCR" CROMO SATINATO "CRS" NERO "NE" BIANCO "BNC"	1 1 1 1 OTTONE / BRASS 
909	Coppia pomolo Quadro 55x55 mm decentrato rosette 50x50 mm con bocchette yale o patent. Pair squared knobs 55x55 mm roses 50x50 mm with escutcheons with patent or cylinder hole.	CROMO LUCIDO "OCR" CROMO SATINATO "CRS" NERO "NE" BIANCO "BNC"	1 1 1 1 ZAMA / ZAMAK 

COPPIA
POMOLI

PAIR KNOBS

CODICE	DESCRIZIONE	FINITURE	IMBALLO	
101/C	Pomolo Victoria ø 50 mm Rosetta ad avvitare ø 50 mm			OTTONE / BRASS
	Pull knob Victoria Rose ø 50 mm	OTTONE LUCIDO VERNICIATO "OLV" CROMO LUCIDO "OCR" CROMO SATINATO "CRS" BRONZO GRAFFIATO LUCIDO "OBG" NIKEL SATINATO "NKS"	2 2 2 2 2	
101	Pomolo Victoria ø 50 mm Rosetta ovale con fori in vista.			OTTONE / BRASS
	Pull knob Victoria oval rose with screw holes.	OTTONE LUCIDO VERNICIATO "OLV" CROMO LUCIDO "OCR" CROMO SATINATO "CRS" BRONZO GRAFFIATO LUCIDO "OBG" NIKEL SATINATO "NKS"	2 2 2 2 2	
127/N	Pomolo Nettuno ø 70 mm con rosone e accessori fissaggio esterno e passante.			OTTONE / BRASS
	Pull knob Nettuno ø 70 mm fixing system included.	OTTONE LUCIDO PVD "PVD" OTTONE LUCIDO VERNICIATO "OLV" CROMO SATINATO "CRS" BRONZO GRAFFIATO LUCIDO "OBG"	2 2 2 2	
129	Pomolo Gamma ø 70 mm con rosone e accessori fissaggio esterno e passante.			ZAMA / ZAMAK
	Pull knob Gamma ø 70 mm fixing system included.	OTTONE LUCIDO VERNICIATO "OLV" CROMO SATINATO "CRS" BRONZO GRAFFIATO LUCIDO "OBG"	2 2 2	
127	Pomolo Margherita ø 70 mm con rosone e accessori fissaggio esterno e passante.			OTTONE / BRASS
	Pull knob Margherita ø 70 mm fixing system included.	OTTONE LUCIDO PVD "PVD" OTTONE LUCIDO VERNICIATO "OLV" CROMO SATINATO "CRS" BRONZO GRAFFIATO LUCIDO "OBG"	2 2 2 2	





CODICE	DESCRIZIONE	FINITURE	IMBALLO	
114	Pomolo Bongo ø 70 mm montaggio esterno con rosetta ø 50 mm accessori fissaggio.			OTTONE / BRASS
	Pull knob Bongo ø 70 mm rose ø 50 mm external fixing system included.	OTTONE LUCIDO VERNICIATO "OLV" CROMO SATINATO "CRS" BRONZO GRAFFIATO LUCIDO "OBG"	2 2 2	
129/E	Pomolo Gamma ø 70 mm montaggio esterno con rosetta ø 50 mm accessori fissaggio.			ZAMA / ZAMAK
	Pull knob Gamma ø 70 mm rose ø 50 mm external fixing system included.	OTTONE LUCIDO VERNICIATO "OLV" CROMO SATINATO "CRS" BRONZO GRAFFIATO LUCIDO "OBG"	2 2 2	
123	Pomolo Cipolla monoblocco ø 67 mm con accessori per montaggio esterno.			OTTONE / BRASS
	Pull knob Cipolla ø 67 mm external fixing system included.	OTTONE LUCIDO VERNICIATO "OLV" CROMO SATINATO "CRS" BRONZO GRAFFIATO LUCIDO "OBG"	2 2 2	
132	Pomolo Centroporta monoblocco ø 67 mm con accessori per montaggio esterno.			OTTONE / BRASS
	Pull knob Centroporta ø 67 mm external fixing system included.	OTTONE LUCIDO VERNICIATO "OLV" CROMO SATINATO "CRS" BRONZO GRAFFIATO LUCIDO "OBG"	2 2 2	
128/E	Pomolo Svezia ø 65 mm montaggio esterno con rosetta ø 50 mm accessori fissaggio.			OTTONE / BRASS
	Pull knob Svezia ø 65 mm rose ø 50 mm external fixing system included.	OTTONE LUCIDO PVD "PVD" OTTONE LUCIDO VERNICIATO "OLV" CROMO SATINATO "CRS" BRONZO GRAFFIATO LUCIDO "OBG"	2 2 2 2	

POMOLI
SINGOLI FISSI

SINGLE KNOBS

CODICE	DESCRIZIONE	FINITURE	IMBALLO	
128	<p>Pomolo Svezia ø 65 mm con rosone e accessori fissaggio esterno e passante.</p> <p>Pull knob Svezia ø 65 mm external fixing system included.</p>	<p>OTTONE LUCIDO PVD "PVD" OTTONE LUCIDO VERNICIATO "OLV" CROMO SATINATO "CRS" BRONZO GRAFFIATO LUCIDO "OBG"</p>	<p>2 2 2 2</p>	<p>OTTONE / BRASS</p> 
133	<p>Pomolo Blog misure: ø 55 mm - ø 65 mm tondo a cilindro con rosetta ø 50 mm e accessori montaggio.</p> <p>Pull knob Blog size: ø 55 mm - ø 65 mm rose ø 50 mm external fixing system included.</p>	<p>ø 55 mm</p> <p>CROMO LUCIDO "OCR" CROMO SATINATO "CRS" NERO "NE"</p> <hr/> <p>ø 65 mm</p> <p>CROMO LUCIDO "OCR" CROMO SATINATO "CRS" NERO "NE"</p>	<p>2 2 2</p> <hr/> <p>2 2 2</p>	<p>ZAMA / ZAMAK</p> 
906	<p>Pomolo Quadro 60x60 mm rosetta quadra 50x50 mm con accessori di montaggio.</p> <p>Squared knob 60x60 mm squared rose 50x50 mm external fixing system included.</p>	<p>CROMO LUCIDO "OCR" CROMO SATINATO "CRS" NERO "NE" BIANCO "BNC"</p>	<p>2 2 2 2</p>	<p>OTTONE / BRASS</p> 
907	<p>Pomolo Quadro 55x55 mm rosetta quadra 50x50 mm con accessori di montaggio.</p> <p>Squared knob 55x55 mm squared rose 50x50 mm external fixing system included.</p>	<p>CROMO LUCIDO "OCR" CROMO SATINATO "CRS" NERO "NE" BIANCO "BNC"</p>	<p>2 2 2 2</p>	<p>ZAMA / ZAMAK</p> 

CODICE	DESCRIZIONE	FINITURE	IMBALLO	
400/CBL	Nottolino a farfalla con rosette tonde ø 45 mm. Wc pawl roses ø 45 mm.	OTTONE LUCIDO VERNICIATO "OLV" BRONZO GRAFFIATO LUCIDO "OBG" CROMO LUCIDO "OCR" CROMO SATINATO "CRS" NIKEL SATINATO "NKS"	6 6 6 6 6	OTTONE - BRASS 
400/CBP	Nottolino a farfalla con rosette tonde ad avvitare ø 50 mm. Wc pawl roses ø 50 mm.	OTTONE LUCIDO VERNICIATO "OLV" BRONZO GRAFFIATO LUCIDO "OBG" CROMO LUCIDO "OCR" CROMO SATINATO "CRS" NIKEL SATINATO "NKS"	6 6 6 6 6	OTTONE - BRASS 
470/CBQ	Nottolino a cubo rosette quadre 50x50 mm. Wc pawl roses 50x50 mm.	CROMO LUCIDO "OCR" CROMO SATINATO "CRS"	6 6	ZAMA - ZAMAK 
400/CBQ	Nottolino rettangolare con rosette quadre 50x50 mm. Wc pawl roses 50x50 mm. DISPONIBILI ANCHE CON SEGNALE DI PRESENZA: ROSSO/BIANCO	CROMO LUCIDO "OCR" CROMO SATINATO "CRS"	6 6	ZAMA - ZAMAK 
R/WCA	Nottolino Wc in acciaio inox Rosette ø 50 mm con segnalatore di presenza libero/occupato Inox Wc pawl roses ø 50 mm with indicator.	INOX/SAT	4	INOX 
R/WCB	Nottolino Wc in acciaio inox Rosette ø 50 mm. Inox Wc pawl roses ø 50 mm.	INOX/SAT	4	INOX 

CODICE	DESCRIZIONE	FINITURE	IMBALLO	
400/TC	Nottolino oliva con rosette tonde ø 45 mm. Wc pawl roses ø 45 mm.		ZAMA/OTTONE - ZAMAK/BRASS	
		OTTONE LUCIDO VERNICIATO "OLV" CROMO LUCIDO "OCR" CROMO SATINATO "CRS"	6 6 6	
400/LO	Nottolino oliva con rosette tonde ø 45 mm con segnalatore di presenza libero/occupato. Wc pawl roses ø 45 mm with indicator.		ZAMA/OTTONE - ZAMAK/BRASS	
		OTTONE LUCIDO VERNICIATO "OLV" CROMO LUCIDO "OCR" CROMO SATINATO "CRS"	6 6 6	
400/RM5	Nottolino farfalla con rosette tonde ø 45 mm viti in vista. Wc pawl roses ø 45 mm.		OTTONE - BRASS	
		OTTONE INVECCHIATO PROTETTO "OIP" OTTONE LUCIDO VERNICIATO "OLV" NIKEL NERO FERROANTICO "NA"	6 6 6	
400	Solo nottolino a farfalla senza rosette. Only lever for Wc pawl without roses.		ZAMA/OTTONE - ZAMAK/BRASS	
		OTTONE LUCIDO VERNICIATO "OLV" CROMO LUCIDO "OCR" CROMO SATINATO "CRS" BRONZO GRAFFIATO LUCIDO "OBG"	10 10 10 10	
400/E	Solo nottolino oliva senza rosette. Only lever for Wc pawl without roses.		ZAMA/OTTONE - ZAMAK/BRASS	
		OTTONE LUCIDO VERNICIATO "OLV" CROMO LUCIDO "OCR" CROMO SATINATO "CRS"	10 10 10	

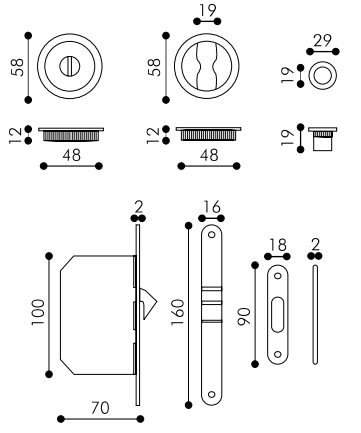
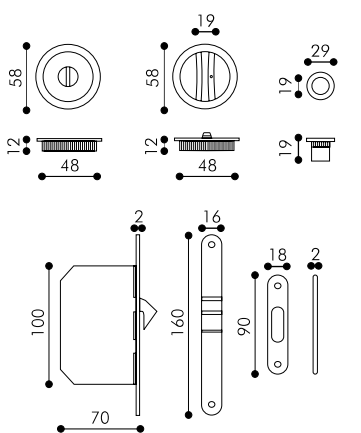
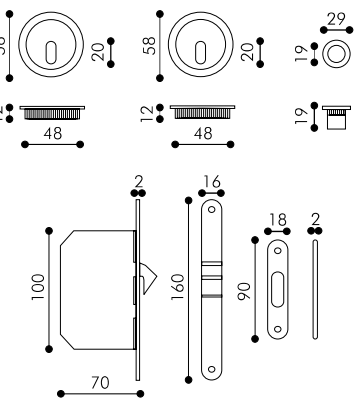
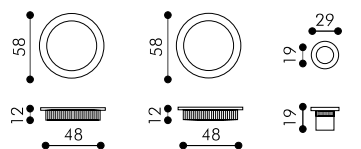
CODICE	DESCRIZIONE	FINITURE	IMBALLO
94/SP	<p>Kit nicchie tonde ø 58 mm con nottolino di chiusura e ditale di trascinamento con serratura.</p> <p>Sliding door kit with round flush handles ø 58 mm with latch and finger pull with lock.</p>	<p>OTTONE LUCIDO VERNICIATO "OLV" CROMO LUCIDO "OCR" CROMO SATINATO "CRS" BRONZO GRAFFIATO LUCIDO "OBG" NERO "NE"</p>	<p>1 1 1 1 1 1</p> 
94	<p>Kit nicchie tonde ø 58 mm con nottolino di chiusura e ditale di trascinamento con serratura.</p> <p>Sliding door kit with round flush handles ø 58 mm with latch and finger pull with lock.</p>	<p>OTTONE LUCIDO VERNICIATO "OLV" CROMO LUCIDO "OCR" CROMO SATINATO "CRS" BRONZO GRAFFIATO LUCIDO "OBG" BRONZO GRAFFIATO OPACO "OBM" BIANCO "BNC" NERO "NE"</p>	<p>1 1 1 1 1 1 1</p> 
95	<p>Kit nicchie tonde ø 58 mm con chiave snodata e ditale di trascinamento con serratura.</p> <p>Sliding door kit with round flush handles ø 58 mm with key hole and finger pull with lock.</p>	<p>OTTONE LUCIDO VERNICIATO "OLV" CROMO LUCIDO "OCR" CROMO SATINATO "CRS" BRONZO GRAFFIATO LUCIDO "OBG" BRONZO GRAFFIATO OPACO "OBM" NERO "NE"</p>	<p>1 1 1 1 1 1</p> 
95/SF	<p>Kit nicchie tonde ø 58 mm senza foro con ditale di trascinamento senza serratura.</p> <p>Sliding door kit with round flush handles ø 58 mm and finger pull without lock.</p>	<p>OTTONE LUCIDO VERNICIATO "OLV" CROMO LUCIDO "OCR" CROMO SATINATO "CRS" BRONZO GRAFFIATO LUCIDO "OBG" BRONZO GRAFFIATO OPACO "OBM" BIANCO "BNC" NERO "NE"</p>	<p>1 1 1 1 1 1</p> 

**KIT PER
 SCORREVOLI**

SLIDING SETS

CODICE	DESCRIZIONE	FINITURE	IMBALLO
94/SP/Q	<p>Kit nicchie quadre 55x55 mm con nottolino di chiusura e ditale di trascinamento con serratura.</p> <p>Sliding door kit with square flush handles 55x55 mm with latch and finger pull with lock.</p>	<p>CROMO LUCIDO "OCR" CROMO SATINATO "CRS" NERO "NE"</p>	<p>1 1 1</p>
94/Q	<p>Kit nicchie quadre 55x55 mm con nottolino di chiusura e ditale di trascinamento con serratura.</p> <p>Sliding door kit with square flush handles 55x55 mm with latch and finger pull with lock.</p>	<p>OTTONE LUCIDO VERNICIATO "OLV" CROMO LUCIDO "OCR" CROMO SATINATO "CRS" BRONZO GRAFFIATO OPACO "OBM" BIANCO "BNC" NERO "NE"</p>	<p>1 1 1 1 1 1</p>
95/Q	<p>Kit nicchie quadre 55x55 mm con chiave snodata e ditale di trascinamento con serratura.</p> <p>Sliding door kit with square flush handles 55x55 mm with key hole and finger pull with lock.</p>	<p>OTTONE LUCIDO VERNICIATO "OLV" CROMO LUCIDO "OCR" CROMO SATINATO "CRS" BRONZO GRAFFIATO OPACO "OBM" NERO "NE"</p>	<p>1 1 1 1 1 1</p>
95/SF/Q	<p>Kit nicchie quadre 55x55 mm senza foro con ditale di trascinamento senza serratura.</p> <p>Sliding door kit with square flush handles 55x55 mm and finger pull without lock.</p>	<p>OTTONE LUCIDO VERNICIATO "OLV" CROMO LUCIDO "OCR" CROMO SATINATO "CRS" BRONZO GRAFFIATO OPACO "OBM" BIANCO "BNC" NERO "NE"</p>	<p>1 1 1 1 1 1</p>

**KIT PER
SCORREVOLI**

SLIDING SETS

CODICE	DESCRIZIONE	FINITURE	IMBALLO
14	<p>Kit nicchie tonde ø 70 mm con nottolino di chiusura e ditale di trascinamento con serratura.</p> <p>Sliding door kit with round flush handles ø 70 mm with latch and finger pull with lock.</p>	<p>OTTONE LUCIDO VERNICIATO "OLV" CROMO LUCIDO "OCR" CROMO SATINATO "CRS"</p>	<p>1 1 1</p> 



15	<p>Kit nicchie tonde ø 70 mm con chiave snodata e ditale di trascinamento con serratura.</p> <p>Sliding door kit with round flush handles ø 70 mm with key hole and finger pull with lock.</p>	<p>OTTONE LUCIDO VERNICIATO "OLV" CROMO LUCIDO "OCR" CROMO SATINATO "CRS"</p>	<p>1 1 1</p> 
----	---	---	---



15/SF	<p>Kit nicchie tonde ø 70 mm senza foro con ditale di trascinamento senza serratura.</p> <p>Sliding door kit with round flush handles ø 70 mm and finger pull without lock.</p>	<p>OTTONE LUCIDO VERNICIATO "OLV" CROMO LUCIDO "OCR" CROMO SATINATO "CRS"</p>	<p>1 1 1</p> 
-------	--	---	--



**KIT CON CORNICI
 MAGGIORATE**

CODICE	DESCRIZIONE	FINITURE	IMBALLO
14/Q	<p>Kit nicchie quadre 70x70 mm con nottolino di chiusura e ditale di trascinamento con serratura.</p> <p>Sliding door kit with square flush handles 70x70 mm with latch and finger pull with lock.</p>	<p>CROMO LUCIDO "OCR" CROMO SATINATO "CRS"</p>	<p>1 1</p> 



15/Q	<p>Kit nicchie quadre 70x70 mm con chiave snodata e ditale di trascinamento con serratura.</p> <p>Sliding door kit with square flush handles 70x70 mm with key hole and finger pull with lock.</p>	<p>CROMO LUCIDO "OCR" CROMO SATINATO "CRS"</p>	<p>1 1</p> 
-------------	---	--	---



15/SF/Q	<p>Kit nicchie quadre 70x70 mm senza foro con ditale di trascinamento senza serratura.</p> <p>Sliding door kit with square flush handles 70x70 mm and finger pull without lock.</p>	<p>CROMO LUCIDO "OCR" CROMO SATINATO "CRS"</p>	<p>1 1</p> 
----------------	--	--	--



**KIT CON CORNICI
MAGGIORATE**

REAL KIT

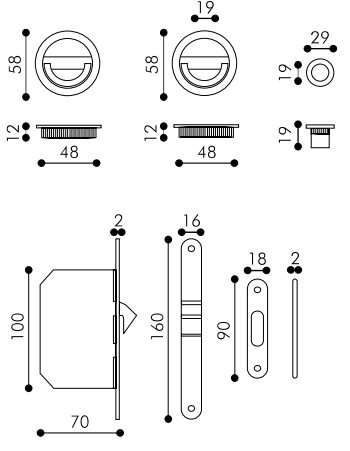
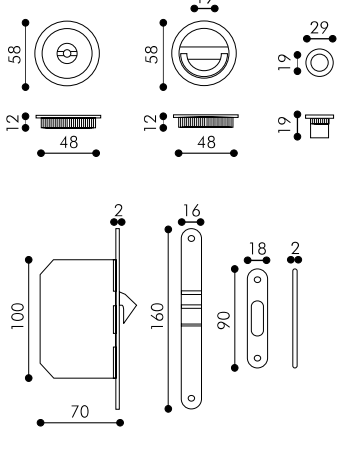
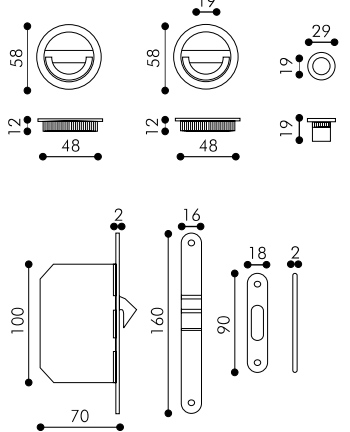
CODICE	DESCRIZIONE	FINITURE	IMBALLO
94/A	<p>Kit nicchie tonde ø 58 mm con doppio anello pendente azionante da entrambi i lati e ditale di trascinamento con serratura.</p> <p>utilizzabile anche per porte a pacchetto</p> <p>Sliding door kit with round flush handles ø 58 mm with double ring latch working on both sides and finger pull with lock.</p>	<p>OTTONE LUCIDO VERNICIATO "OLV" CROMO LUCIDO "OCR" CROMO SATINATO "CRS" BRONZO GRAFFIATO LUCIDO "OBG"</p>	<p>1 1 1 1</p> 
94/AT	<p>Kit nicchie tonde ø 58 mm con anello pendente e nottolino per apertura di sicurezza e ditale di trascinamento con serratura.</p> <p>Sliding door kit with round flush handles ø 58 mm with single ring latch and finger pull with lock.</p>	<p>OTTONE LUCIDO VERNICIATO "OLV" CROMO LUCIDO "OCR" CROMO SATINATO "CRS" BRONZO GRAFFIATO LUCIDO "OBG"</p>	<p>1 1 1 1</p> 
94/AF	<p>Kit nicchie tonde ø 58 mm con doppio anello pendente azionante solo lato interno e ditale di trascinamento con serratura.</p> <p>Sliding door kit with round flush handles ø 58 mm with double ring latch working only on internal side and finger pull with lock.</p>	<p>OTTONE LUCIDO VERNICIATO "OLV" CROMO LUCIDO "OCR" CROMO SATINATO "CRS" BRONZO GRAFFIATO LUCIDO "OBG"</p>	<p>1 1 1 1</p> 

**KIT PER SCORREVOLI
 CON ANELLO PENDENTE**

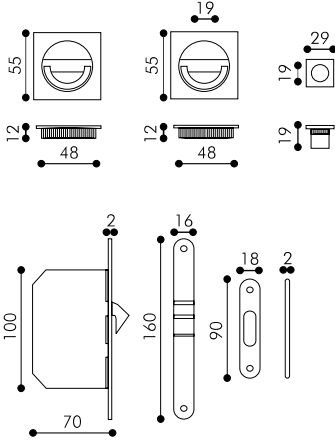
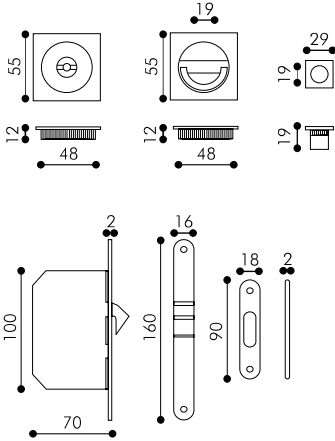
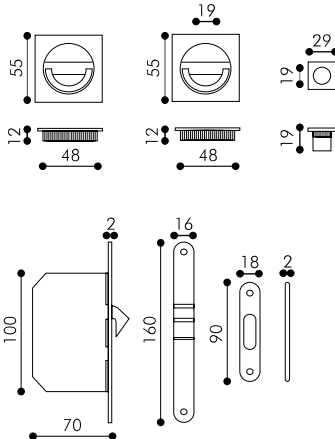
CODICE	DESCRIZIONE	FINITURE	IMBALLO
94/A/Q	<p>Kit nicchie quadre 55x55 mm con doppio anello pendente azionante da entrambi i lati con ditale di trascimento con serratura</p> <p><i>utilizzabile anche per porte a pacchetto</i></p> <p>Sliding door kit with round flush handles 55x55 mm with double ring latch working on both sides and finger pull with lock.</p>	<p>CROMO LUCIDO "OCR" CROMO SATINATO "CRS"</p>	<p>1 1</p> 
94/AT/Q	<p>Kit nicchie quadre 55x55 mm con anello pendente e nottolino per apertura di sicurezza con ditale di trascimento con serratura</p> <p>Sliding door kit with square flush handles 55x55 mm with single ring latch and finger pull with lock.</p>	<p>CROMO LUCIDO "OCR" CROMO SATINATO "CRS"</p>	<p>1 1</p> 
94/AF/Q	<p>Kit nicchie quadre 55x55 mm con doppio anello pendente azionante solo lato interno con ditale di trascimento con serratura</p> <p>Sliding door kit with square flush handles 55x55 mm with double ring latch working only on internal side and finger pull with lock.</p>	<p>CROMO LUCIDO "OCR" CROMO SATINATO "CRS"</p>	<p>1 1</p> 

KIT PER SCORREVOLI
CON ANELLO PENDENTE

SLIDING SETS

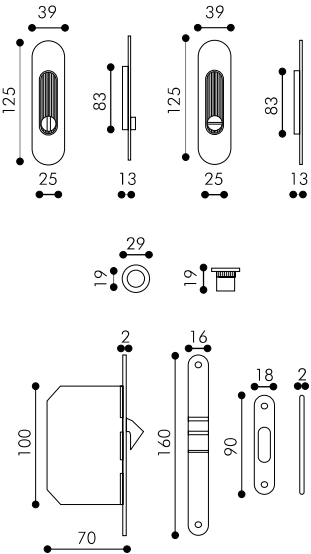
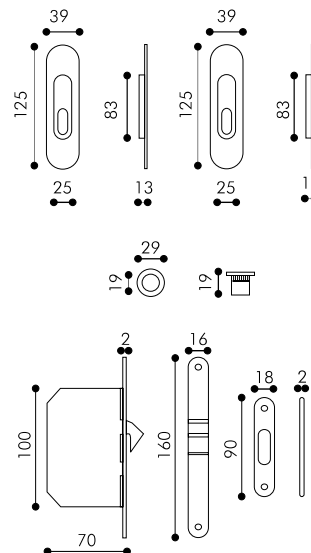
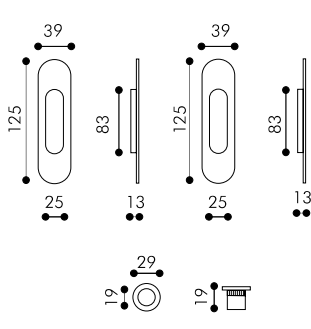
CODICE	DESCRIZIONE	FINITURE	IMBALLO	
98	<p>Kit nicchie ovali con nottolino di chiusura e ditale di trascinamento con serratura.</p> <p>Sliding door kit with oval flush handles with latch and finger pull with lock.</p>	<p>OTTONE LUCIDO VERNICIATO "OLV" CROMO SATINATO "CRS"</p>	<p>1 1</p>	
99	<p>Kit nicchie ovali con chiave snodata e ditale di trascinamento con serratura.</p> <p>Sliding door kit with oval flush handles with key hole and finger pull with lock.</p>	<p>OTTONE LUCIDO VERNICIATO "OLV" CROMO SATINATO "CRS"</p>	<p>1 1</p>	
98/SF	<p>Kit nicchie ovali senza foro con ditale di trascinamento senza serratura.</p> <p>Sliding door kit with oval flush handles and finger pull without lock.</p>	<p>OTTONE LUCIDO VERNICIATO "OLV" CROMO SATINATO "CRS"</p>	<p>1 1</p>	



KIT PER
SCORREVOLI

SLIDING SETS

CODICE	DESCRIZIONE	FINITURE	IMBALLO
98/R	<p>Kit nicchie rettangolari con nottolino di chiusura e ditale di trascinamento con serratura.</p> <p>Sliding door kit with rectangular flush handles with latch and finger pull with lock.</p>	<p>OTTONE LUCIDO VERNICIATO "OLV" CROMO SATINATO "CRS"</p> 	<p>1 1</p> 

99/R	<p>Kit nicchie rettangolari con chiave snodata e ditale di trascinamento con serratura.</p> <p>Sliding door kit with rectangular flush handles with key hole and finger pull with lock.</p>	<p>OTTONE LUCIDO VERNICIATO "OLV" CROMO SATINATO "CRS"</p> 	<p>1 1</p> 
------	--	---	---

98/SF/R	<p>Kit nicchie rettangolari senza foro con ditale di trascinamento senza serratura.</p> <p>Sliding door kit with rectangular flush handles and finger pull without lock.</p>	<p>OTTONE LUCIDO VERNICIATO "OLV" CROMO SATINATO "CRS"</p> 	<p>1 1</p> 
---------	---	---	--

CODICE	DESCRIZIONE	FINITURE	IMBALLO	
201/ATP	Singola placca ad incasso ovale 39x125 mm fori vite coperti con o senza foro chiave. Sliding oval flush handle with or without key hole.	OTTONE LUCIDO VERNICIATO "OLV"	6	
		CROMO LUCIDO "OCR"	6	
		CROMO SATINATO "CRS"	6	
		BRONZO GRAFFIATO LUCIDO "OBG"	6	
	disponibile nella versione:			
	- senza foro chiave			
	- foro chiave centrale			
	- foro chiave basso			
				
201/ATP/R	Singola placca ad incasso rettangolare 39x125 mm fori vite coperti con o senza foro chiave. Sliding rectangular flush handle with or without key hole.	OTTONE LUCIDO VERNICIATO "OLV"	6	
		CROMO LUCIDO "OCR"	6	
		CROMO SATINATO "CRS"	6	
		BRONZO GRAFFIATO LUCIDO "OBG"	6	
	disponibile nella versione:			
	- senza foro chiave			
	- foro chiave centrale			
	- foro chiave basso			
				
207	Singola placca ad incasso da 245x40 mm con o senza foro chiave scasso 90x30 mm. Sliding big oval flush handle with or without key hole.	OTTONE LUCIDO VERNICIATO "OLV"	12	
		CROMO SATINATO "CRS"	12	
		BRONZO GRAFFIATO LUCIDO "OBG"	12	

ACCESSORI PER
SCORREVOLI

CODICE	DESCRIZIONE	FINITURE	IMBALLO	
90	Anello di trascinamento ad incasso base 55x40 mm. Sliding ring.	OTTONE LUCIDO VERNICIATO "OLV"	12	
		CROMO LUCIDO "OCR"	12	
		CROMO SATINATO "CRS"	12	
		BRONZO GRAFFIATO LUCIDO "OBG"	12	
202/SP	Singole nicchiette di trascinamento per scorrevoli. Sliding round flush handle.	foro mm 26 esterno mm 30		
		OTTONE LUCIDO VERNICIATO "OLV"	12	
		CROMO LUCIDO "OCR"	12	
		CROMO SATINATO "CRS"	12	
		BRONZO GRAFFIATO LUCIDO "OBG"	12	
		foro mm 35 esterno mm 40		
		OTTONE LUCIDO VERNICIATO "OLV"	12	
		CROMO LUCIDO "OCR"	12	
		CROMO SATINATO "CRS"	12	
		BRONZO GRAFFIATO LUCIDO "OBG"	12	
		foro mm 40 esterno mm 45		
		OTTONE LUCIDO VERNICIATO "OLV"	12	
		CROMO LUCIDO "OCR"	12	
		CROMO SATINATO "CRS"	12	
		BRONZO GRAFFIATO LUCIDO "OBG"	12	
202	Singola placca ad incasso tonda ø 58 mm con o senza foro chiave. Single round flush handle ø 58 mm with or without key hole.	OTTONE LUCIDO VERNICIATO "OLV"	12	
		CROMO LUCIDO "OCR"	12	
		CROMO SATINATO "CRS"	12	
		BRONZO GRAFFIATO LUCIDO "OBG"	12	
		NERO "NE"	12	
202/Q	Singola placca ad incasso con bordo quadro 55x55 mm con o senza foro chiave. Single square flush handle 55x55 mm with or without key hole.	OTTONE LUCIDO VERNICIATO "OLV"	12	
		CROMO LUCIDO "OCR"	12	
		CROMO SATINATO "CRS"	12	
		BRONZO GRAFFIATO OPACO "OBM"	12	
		BIANCO "BNC"	12	
		NERO "NE"	12	

CODICE	DESCRIZIONE	FINITURE	IMBALLO	
203	Ditale per scorrevoli ø 29mm con bordo tondo. Round finger pull ø 29 mm.	OTTONE LUCIDO VERNICIATO "OLV"	12	
		CROMO LUCIDO "OCR"	12	
		CROMO SATINATO "CRS"	12	
		BRONZO GRAFFIATO LUCIDO "OBG"	12	
203/Q	Ditale per scorrevoli 29x29 mm con bordo quadro. Square finger pull 29x29 mm.	OTTONE LUCIDO VERNICIATO "OLV"	12	
		CROMO LUCIDO "OCR"	12	
		CROMO SATINATO "CRS"	12	
		BRONZO GRAFFIATO OPACO "OBM"	12	
222	Placca ad incasso quadra lux 59x59 mm foro scasso 48 mm con labbro e foro sagomato mezza luna. Square flush handle 59x59 mm internal 48 mm.	OTTONE LUCIDO VERNICIATO "OLV"	6	
		CROMO LUCIDO "OCR"	6	
		CROMO SATINATO "CRS"	6	
		BRONZO GRAFFIATO LUCIDO "OBG"	6	
223	Placca ad incasso tonda Pesante ø 59 mm foro scasso 48 mm con labbro interno e cornice maggiorata. Round flush handle ø 59 mm internal 48 mm.	OTTONE LUCIDO VERNICIATO "OLV"	6	
		CROMO LUCIDO "OCR"	6	
		CROMO SATINATO "CRS"	6	
		BRONZO GRAFFIATO LUCIDO "OBG"	6	
224	Placca ad incasso tonda ø 59 scasso 48 mm con labbro e foro sagomato mezza luna. Round flush handle ø 59 mm internal 48 mm.	OTTONE LUCIDO VERNICIATO "OLV"	6	
		CROMO LUCIDO "OCR"	6	
		CROMO SATINATO "CRS"	6	
		BRONZO GRAFFIATO LUCIDO "OBG"	6	
971	Maniglioncino completo di kit per fissaggio. Pull handle Fixing system included	160 mm		
		OTTONE LUCIDO VERNICIATO "OLV"	12	
		CROMO SATINATO "CRS"	12	
		BRONZO GRAFFIATO LUCIDO "OBG"	12	
		200 mm		
		OTTONE LUCIDO VERNICIATO "OLV"	12	
		CROMO SATINATO "CRS"	12	
		BRONZO GRAFFIATO LUCIDO "OBG"	12	

ACCESSORI PER
SCORREVOLI

CODICE	DESCRIZIONE	FINITURE	IMBALLO
350	<p>Maniglione alzante tondo con placca incasso esterna e kit di fissaggio.</p> <p>Single lift and slide handle with external plate fixing system included.</p> 	<p>OTTONE LUCIDO VERNICIATO "OLV" CROMO SATINATO "CRS" BRONZO GRAFFIATO LUCIDO "OBG"</p>	<p>OTTONE / BRASS</p>  <p>1 1 1</p>
351	<p>Coppia di maniglioni alzanti tondi foro yale in ottone con kit fissaggio.</p> <p>Pair lift and slide handles with yale hole fixing system included.</p> 	<p>OTTONE LUCIDO VERNICIATO "OLV" CROMO SATINATO "CRS" BRONZO GRAFFIATO LUCIDO "OBG"</p>	<p>OTTONE / BRASS</p>  <p>1 1 1</p>
370	<p>Maniglione alzante quadro con placca incasso esterna e kit di fissaggio.</p> <p>Single lift and slide handle with external plate fixing system included.</p> 	<p>CROMO LUCIDO "OCR" CROMO SATINATO "CRS" BIANCO "BNC" NERO "NE"</p>	<p>ZAMA / ZAMAK</p>  <p>1 1 1 1</p>
371	<p>Coppia di maniglioni alzanti quadri foro yale con kit fissaggio</p> <p>Pair lift and slide handles with yale hole fixing system included.</p> 	<p>CROMO LUCIDO "OCR" CROMO SATINATO "CRS" BIANCO "BNC" NERO "NE"</p>	<p>ZAMA / ZAMAK</p>  <p>1 1 1 1</p>

ALZANTI PER SCORREVOLI

CODICE	DESCRIZIONE	FINITURE	IMBALLO
8069/A	Impugnatura MANIGLIA DOLLY con pomolo Svezia fisso e rosetta ø 50 mm sistema di montaggio A.	OTTONE LUCIDO VERNICIATO "OLV" CROMO SATINATO "CRS" BRONZO GRAFFIATO LUCIDO "OBG"	OTTONE / BRASS 1 1 1
	Handle Dolly knob Svezia on rose ø 50 mm fixed mounting system A.		

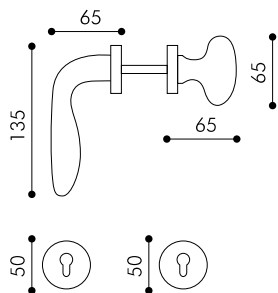

7809/A	Impugnatura MANIGLIA DUNA con pomolo Svezia fisso e rosetta ø 50 mm sistema di montaggio A.	OTTONE LUCIDO VERNICIATO "OLV" CROMO SATINATO "CRS" BRONZO GRAFFIATO LUCIDO "OBG"	OTTONE / BRASS 1 1 1
	Handle Duna knob Svezia on rose ø 50 mm fixed mounting system A.		

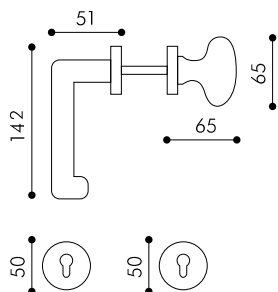

A Schema di montaggio A
con niples.

Mounting system A.

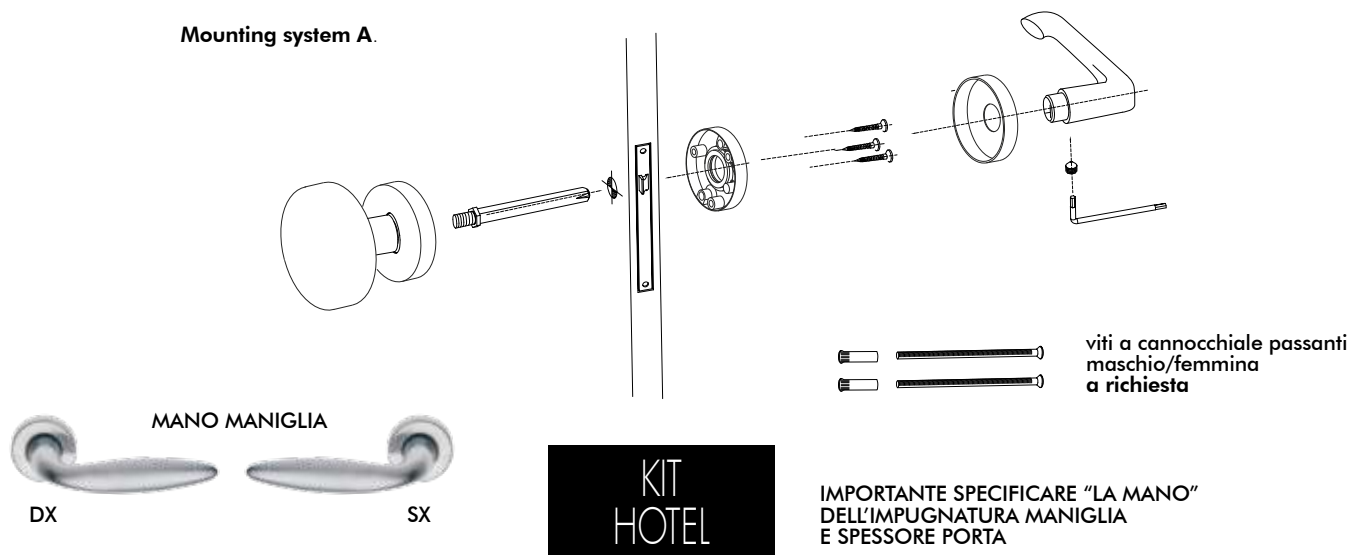

CODICE	DESCRIZIONE	FINITURE	IMBALLO
8069/B	<p>Impugnatura MANIGLIA DOLLY con pomolo Svezia fisso e rosetta ø 50 mm sistema di montaggio B.</p> <p>Handle Dolly knob Svezia on rose ø 50 mm fixed mounting system B.</p>	<p>OTTONE LUCIDO VERNICIATO "OLV" CROMO SATINATO "CRS" BRONZO GRAFFIATO LUCIDO "OBG"</p>	<p>OTTONE / BRASS</p> <p>1 1 1</p>

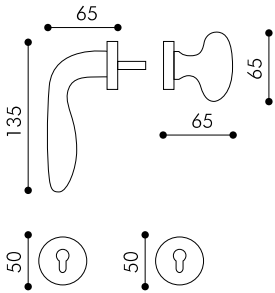

7809/B	<p>Impugnatura MANIGLIA DUNA con pomolo Svezia fisso e rosetta ø 50 mm sistema di montaggio B.</p> <p>Handle Duna knob Svezia on rose ø 50 mm fixed mounting system B.</p>	<p>OTTONE LUCIDO VERNICIATO "OLV" CROMO SATINATO "CRS" BRONZO GRAFFIATO LUCIDO "OBG"</p>	<p>OTTONE / BRASS</p> <p>1 1 1</p>
---------------	--	--	--

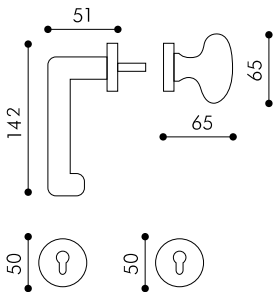

B **Schema di montaggio B**
 con quadro
 ad espansione e dummy.

Mounting system B.

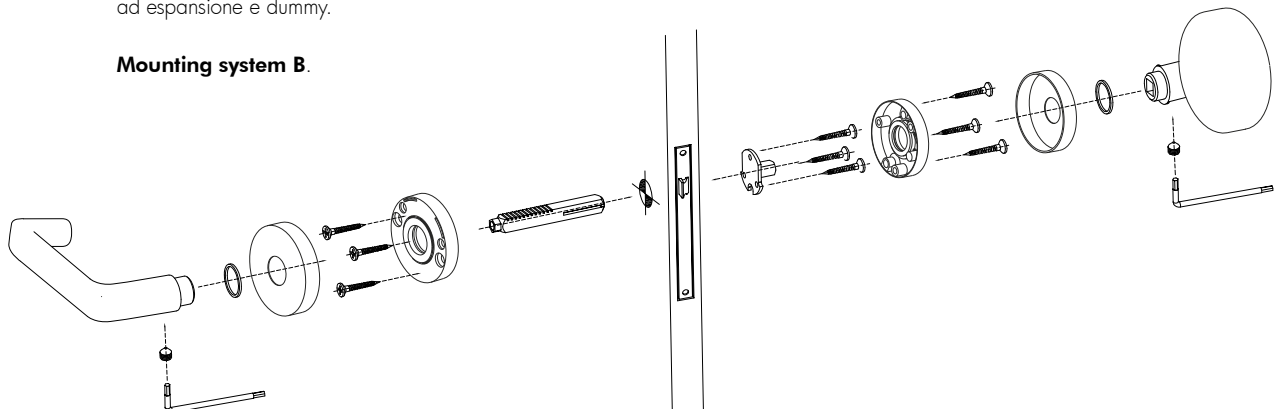

**IMPORTANTE SPECIFICARE "LA MANO"
 DELL'IMPUGNATURA MANIGLIA
 E SPESSORE PORTA**



CODICE	DESCRIZIONE	FINITURE	IMBALLO
--------	-------------	----------	---------

8099/A

Impugnatura **MANIGLIA QUADRA SPORT**
con pomolo Quadro
fisso e rosetta 50x50 mm
sistema di montaggio A.

Handle Quadra Sport
knob Quadro
on rose 50x50 mm
fixed
mounting system A.

CROMO LUCIDO "OCR"
CROMO SATINATO "CRS"
NERO "NE"

1
1
1

ZAMA / ZAMAK

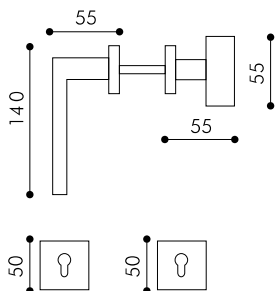

3609/A

Impugnatura **MANIGLIA ISCHIA**
con pomolo Quadro
fisso e rosetta 50x50 mm
sistema di montaggio A.

Handle Ischia
knob Quadro
on rose 50x50 mm
fixed
mounting system A.

CROMO SATINATO "CRS"
NERO "NE"

1
1

ZAMA / ZAMAK

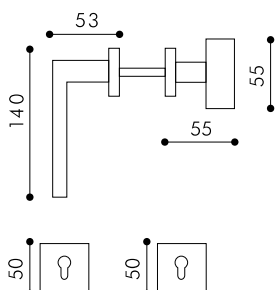

A

Schema di montaggio A
con niples.

Mounting system A

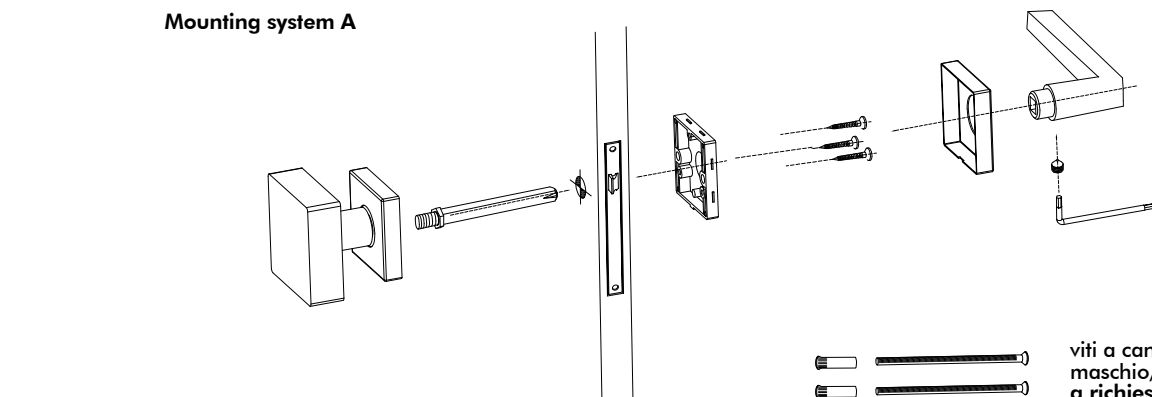

KIT HOTEL

IMPORTANTE SPECIFICARE "LA MANO" DELL'IMPUGNATURA MANIGLIA E SPESSORE PORTA

CODICE	DESCRIZIONE	FINITURE	IMBALLO
8099/B	<p>Impugnatura MANIGLIA QUADRA SPORT con pomolo Quadro fisso e rosetta 50x50 mm sistema di montaggio B.</p> <p>Handle Quadra Sport knob Quadro on rose 50x50 mm fixed mounting system B.</p> 	<p>CROMO LUCIDO "OCR" CROMO SATINATO "CRS" NERO "NE"</p>	<p>ZAMA / ZAMAK</p> <p>1 1 1</p> 

3609/B	<p>Impugnatura MANIGLIA ISCHIA con pomolo Quadro fisso e rosetta 50x50 mm sistema di montaggio B.</p> <p>Handle Ischia knob Quadro on rose 50x50 mm fixed mounting system B.</p> 	<p>CROMO SATINATO "CRS" NERO "NE"</p>	<p>ZAMA / ZAMAK</p> <p>1 1</p> 
--------	--	---	---

B **Schema di montaggio B**
 con quadro
 ad espansione e dummy.

Mounting system B

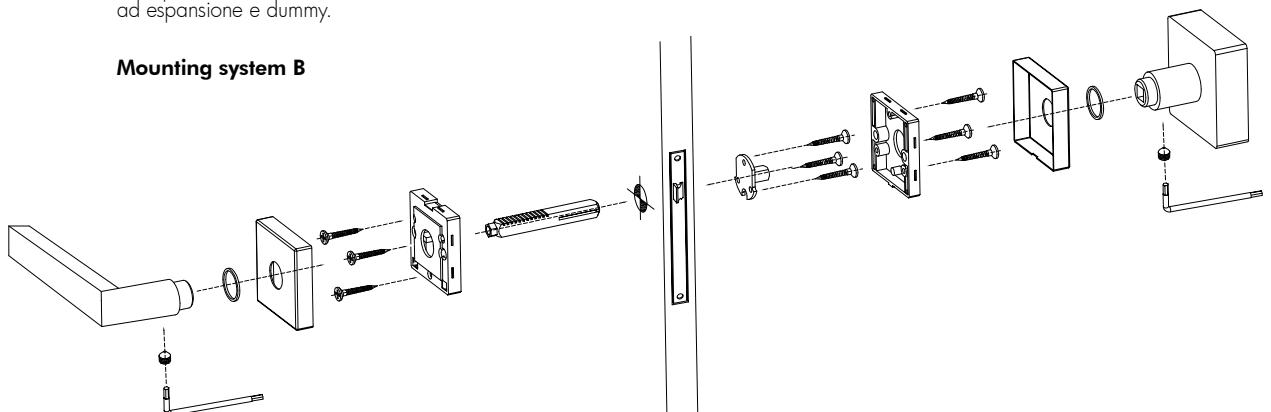

**IMPORTANTE SPECIFICARE "LA MANO"
 DELL'IMPUGNATURA MANIGLIA
 E SPESSORE PORTA**



CODICE	DESCRIZIONE	FINITURE	IMBALLO	
601	Copriavvolgitore 278x56 mm angolo tondo. Roller blind cover.	OTTONE LUCIDO VERNICIATO "OLV" CROMO LUCIDO "OCR" CROMO SATINATO "CRS" BRONZO GRAFFIATO LUCIDO "OBG" NIKEL SATINATO "NKS"	14 14 14 14 14	OTTONE / BRASS 
611	Copriavvolgitore 240x53 mm angolo quadro. Roller blind cover.	OTTONE LUCIDO VERNICIATO "OLV" CROMO LUCIDO "OCR" CROMO SATINATO "CRS" BRONZO GRAFFIATO LUCIDO "OBG" NIKEL SATINATO "NKS"	14 14 14 14 14	OTTONE / BRASS 
630	Guida cinghia Roller guide	OTTONE LUCIDO VERNICIATO "OLV" CROMO SATINATO "CRS" BRONZO GRAFFIATO LUCIDO "OBG"	12 12 12	OTTONE / BRASS 
710	Bucalettere con molla 257x75 mm Letter box plate 257x75 mm	OTTONE LUCIDO VERNICIATO "OLV" CROMO SATINATO "CRS" BRONZO GRAFFIATO LUCIDO "OBG"	1 1 1	OTTONE / BRASS 
700	Bucalettere a cadenza 257x75 mm Letter box plate 257x75 mm	OTTONE LUCIDO VERNICIATO "OLV" CROMO SATINATO "CRS" BRONZO GRAFFIATO LUCIDO "OBG"	1 1 1	OTTONE / BRASS 

**COPRIAVVOLGITORI
E BUCALLETTERE**

CODICE	DESCRIZIONE	FINITURE	IMBALLO
515	Battente Leone. Door knocker.		OTTONE / BRASS

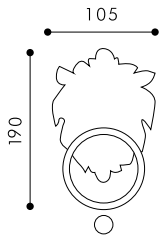

OTTONE LUCIDO VERNICIATO "OLV"	1
OTTONE LUCIDO NATURALE "OLN"	1
OTTONE ANTICATO "OBA"	1
OTTONE INVECCHIATO PROTETTO "OIP"	1
OTTONE AD EFFETTO RUGGINE "ORG"	1



523	Battente Eco. Door knocker.		OTTONE / BRASS
-----	--------------------------------	--	----------------

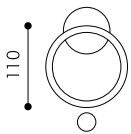

OTTONE LUCIDO VERNICIATO "OLV"	1
OTTONE LUCIDO NATURALE "OLN"	1
OTTONE ANTICATO "OBA"	1
OTTONE INVECCHIATO PROTETTO "OIP"	1
OTTONE AD EFFETTO RUGGINE "ORG"	1



520	Battente ad anello. Door knocker.		OTTONE / BRASS
-----	--------------------------------------	--	----------------

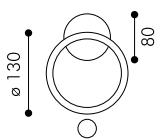

Ø 130 mm - rosone Ø 80 mm	
OTTONE LUCIDO PVD "PVD"	1
OTTONE LUCIDO VERNICIATO "OLV"	1
CROMO SATINATO "CRS"	1
BRONZO GRAFFIATO LUCIDO "OBG"	1



522	Battente Margherita. Door knocker.		OTTONE / BRASS
-----	---------------------------------------	--	----------------

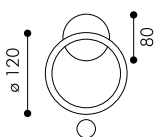

Ø 120 mm - rosone Ø 80 mm	
OTTONE LUCIDO PVD "PVD"	1
OTTONE LUCIDO VERNICIATO "OLV"	1
CROMO SATINATO "CRS"	1
BRONZO GRAFFIATO LUCIDO "OBG"	1



BATTENTI







DOOR KNOCKERS

	DESCRIZIONE	FINITURE	IMBALLO	
R/OV/DEF	Mostrina ovale 82x62 mm con sottoplastica per defender foro ø 46/50 mm. Oval escutcheon 82x62 mm for defender.	OTTONE LUCIDO VERNICIATO "OLV" CROMO LUCIDO "OCR" CROMO SATINATO "CRS" BRONZO GRAFFIATO LUCIDO "OBG"	4 4 4 4	OTTONE / BRASS 
CAP	Rosetta a cappuccio copridefender misura 46/48/50 mm. Cover for defender.	OTTONE LUCIDO VERNICIATO "OLV" CROMO LUCIDO "OCR" CROMO SATINATO "CRS" BRONZO GRAFFIATO LUCIDO "OBG"	4 4 4 4	OTTONE / BRASS 
R/OV/Y	Mostrina ovale 82x62 mm con sottoplastica con foro cilindro yale. Oval escutcheon 82x62 mm with plastic with cylinder hole.	OTTONE LUCIDO VERNICIATO "OLV" CROMO LUCIDO "OCR" CROMO SATINATO "CRS" BRONZO GRAFFIATO LUCIDO "OBG"	4 4 4 4	OTTONE / BRASS 
R/OV/10	Mostrina ovale 82x62 mm con sottoplastica con foro per codolo cilindro ø 10 mm. Oval escutcheon 82x62 mm with ø 10 mm hole.	OTTONE LUCIDO VERNICIATO "OLV" CROMO LUCIDO "OCR" CROMO SATINATO "CRS" BRONZO GRAFFIATO LUCIDO "OBG"	4 4 4 4	OTTONE / BRASS 
481	Pomello per codolo cilindro tipo Farfalla foro ø 8 mm. Cylinder knob ø 8 mm hole.	OTTONE LUCIDO VERNICIATO "OLV" CROMO LUCIDO "OCR" CROMO SATINATO "CRS" BRONZO GRAFFIATO LUCIDO "OBG"	4 4 4 4	ZAMA / ZAMAK 
431	Pomello per codolo cilindro tipo tondo foro ø 8 mm. Cylinder knob ø 8 mm hole.	OTTONE LUCIDO VERNICIATO "OLV" CROMO LUCIDO "OCR" CROMO SATINATO "CRS" BRONZO GRAFFIATO LUCIDO "OBG"	4 4 4 4	OTTONE / BRASS 

CODICE	DESCRIZIONE	FINITURE	IMBALLO	
R/RE/DEF	Mostrina rettangolare 75x62 mm con sottoplastica per defender ø foro 48/50 mm. Rectangular escutcheon 75x62 mm for defender.	CROMO LUCIDO "OCR" CROMO SATINATO "CRS" NERO "NE"	2 2 2	OTTONE / BRASS 
CAP	Rosetta a cappuccio copridefender misura 46/48/50 mm. Cover for defender.	CROMO LUCIDO "OCR" CROMO SATINATO "CRS" NERO "NE"	4 4 4	OTTONE / BRASS 
R/RE/Y	Mostrina rettangolare 75x62 mm con sottoplastica con foro cilindro yale. Rectangular escutcheon 75x62 mm with plastic with cylinder hole.	CROMO LUCIDO "OCR" CROMO SATINATO "CRS" NERO "NE"	2 2 2	OTTONE / BRASS 
R/RE/10	Mostrina rettangolare 75x62 mm con sottoplastica con foro per codolo pomello cilindro Rectangular escutcheon 75x62 mm with ø 10 mm hole.	CROMO LUCIDO "OCR" CROMO SATINATO "CRS" NERO "NE"	2 2 2	OTTONE / BRASS 
CIL/R	Pomello per codolo cilindro tipo rettangolare foro ø 8 mm. Cylinder knob ø 8 mm hole.	CROMO LUCIDO "OCR" CROMO SATINATO "CRS" NERO "NE"	8 8 8	ZAMA / ZAMAK 
CIL/Q	Pomello a cubo per codolo cilindro tipo quadro foro ø 8 mm. Cylinder knob ø 8 mm hole.	CROMO LUCIDO "OCR" CROMO SATINATO "CRS"	8 8	ZAMA / ZAMAK 

ARTICOLI
PER BLINDATI

SERIE QUADRA





CODICE	DESCRIZIONE	FINITURE	IMBALLO	
688	Limitatore di apertura a rotazione tipo Farfalla con entrata per quadrello da 8 mm Rosetta ø 50 mm. Opening limiter.	OTTONE LUCIDO VERNICIATO "OLV" CROMO SATINATO "CRS" BRONZO GRAFFIATO LUCIDO "OBG"	12 12 12	ZAMA / ZAMAK 
682	Limitatore di apertura a rotazione tipo tondo con entrata per quadrello da 8 mm Rosetta ø 50 mm. Opening limiter.	OTTONE LUCIDO VERNICIATO "OLV" CROMO SATINATO "CRS" BRONZO GRAFFIATO LUCIDO "OBG"	8 8 8	ZAMA / ZAMAK 
683	Limitatore di apertura a traslazione su rosone da 82x62 mm ovale. Opening limiter.	OTTONE LUCIDO VERNICIATO "OLV" CROMO SATINATO "CRS" BRONZO GRAFFIATO LUCIDO "OBG"	3 3 3	OTTONE / BRASS 
684	Limitatore di apertura a traslazione su rosone da 82x62 mm rettangolare. Opening limiter.	CROMO LUCIDO "OCR" CROMO SATINATO "CRS" NERO "NE"	3 3 3	OTTONE / BRASS 
982	Limitatore di apertura a rotazione tipo cubo con entrata per quadrello da 8 mm da 50x50 mm. Opening limiter.	CROMO LUCIDO "OCR" CROMO SATINATO "CRS"	3 3	ZAMA / ZAMAK 
988	Limitatore di apertura a rotazione tipo rettangolare con entrata per quadrello da 8 mm da 50x50 mm. Opening limiter.	CROMO LUCIDO "OCR" CROMO SATINATO "CRS" NERO "NE"	3 3 3	ZAMA / ZAMAK 

LIMITATORI DI
APERTURA

OPENING LIMITERS

CODICE	DESCRIZIONE	FINITURE	IMBALLO	
1301/F	Ovalina su rosetta mm 38x64 Ø 8mm fissa o girevole Small window handle with oval rose.	OTTONE LUCIDO VERNICIATO "OLV" CROMO LUCIDO "OCR" CROMO SATINATO "CRS"	8 8 8	OTTONE / BRASS 
1301/S	Ovalina su rosetta mm 25x65 Ø 8mm fissa o girevole Small window handle with oval rose.	OTTONE LUCIDO VERNICIATO "OLV" CROMO LUCIDO "OCR" CROMO SATINATO "CRS"	8 8 8	OTTONE / BRASS 
690	Catenaccio di sicurezza a cremagliera misure disponibili 60 mm - 80 mm Shutter stop.	OTTONE NATURALE "OL" OTTONE BRONZATO "OBV" CROMO SATINATO "CRS" OTTONE INVECCHIATO PROTETTO "OIP"	3 3 3 3	OTTONE / BRASS 
300	Segretino Elegant quadro 6/7 mm Rosetta ovale mm 25x65 Small window handle Elegant with oval rose.	OTTONE LUCIDO VERNICIATO "OLV" CROMO SATINATO "CRS" BRONZO GRAFFIATO LUCIDO "OBG" NIKEL SATINATO "NKS"	8 8 8 8	OTTONE / BRASS 
SP/T	Spioncino base tonda stelo ø 14 mm estensione da 50 a 80 mm oppure estensione da 70 a 120 mm Peephole.	EFFETTO OTTONE LUCIDO "OLV" EFFETTO CROMO SATINATO "ECRS" EFFETTO BRONZO "EOB"	10 10 10	ALLUMINIO / ALUMINIUM 
SP/Q	Spioncino base quadra stelo ø 14 mm estensione da 50 a 80 mm oppure estensione da 70 a 120 mm Peephole.	CROMO LUCIDO "OCR" CROMO SATINATO "CRS"	1 1	ZAMA / ZAMAK 

**SEGRETTINI
E SPIONCINI**

CODICE	DESCRIZIONE	FINITURE	IMBALLO	
720	Supporto corrimano base quadra			OTTONE / BRASS
	Handrail support			
		OTTONE LUCIDO VERNICIATO "OLV"	6	
		CROMO SATINATO "CRS"	6	
		OTTONE BRONZATO "OB"	6	
730	Supporto corrimano testa piana base tonda			OTTONE / BRASS
	Handrail support			
		OTTONE LUCIDO VERNICIATO "OLV"	6	
		CROMO SATINATO "CRS"	6	
		OTTONE BRONZATO "OB"	6	
740	Supporto corrimano testa piana con rosetta			OTTONE / BRASS
	Handrail support with rose			
		OTTONE LUCIDO VERNICIATO "OLV"	6	
		CROMO SATINATO "CRS"	6	
		OTTONE BRONZATO "OB"	6	
880	Maniglie per mobili viti a vista			OTTONE / BRASS
	Furniture handle			
		L C H		
		115 96 21	OTTONE LUCIDO VERNICIATO "OLV"	50
		115 96 21	OTTONE LUCIDO NON VERNICIATO "OLN"	50
		115 96 21	OTTONE SATINATO VERNICIATO "OSL"	50
		115 96 21	CROMO LUCIDO "OCR"	50
		115 96 21	CROMO SATINATO "CRS"	50
		115 96 21	BRONZO GRAFFIATO LUCIDO "OBG"	50
		115 96 21	NIKEL SATINATO "NKS"	50
		150 128 28	OTTONE LUCIDO VERNICIATO "OLV"	24
		150 128 28	OTTONE LUCIDO NON VERNICIATO "OLN"	24
		150 128 28	OTTONE SATINATO VERNICIATO "OSL"	24
		150 128 28	CROMO LUCIDO "OCR"	24
		150 128 28	CROMO SATINATO "CRS"	24
		150 128 28	BRONZO GRAFFIATO LUCIDO "OBG"	24
		150 128 28	NIKEL SATINATO "NKS"	24
680	Tavellino a scatto			OTTONE / BRASS
	Release flat handle			
		inc. mm 5	OTT. NATURALE "OL"	24
		inc. mm 10	OTT. NATURALE "OL"	24
		inc. mm 15	OTT. NATURALE "OL"	24
		inc. mm 20	OTT. NATURALE "OL"	24
		inc. mm 25	OTT. NATURALE "OL"	24
	inc. mm 30	OTT. NATURALE "OL"	24	
		BRONZATO + 15% - CROMATO + 25%		

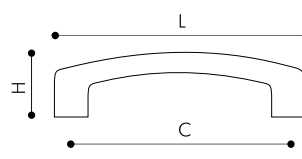

CODICE	DESCRIZIONE	FINITURE	IMBALLO	
1701	Guarnitura su rosette tonde con fori in vista e bocchette con foro patent o foro yale. Pair spring handles on roses and escutcheons with patent or cylinder hole.	OTTONE LUCIDO VERNICIATO "OLV" OTTONE NATURALE "OL"	1 1	
1751	Guarnitura su rosette ovali con fori in vista e bocchette con foro patent o foro yale. Pair spring handles on oval roses and escutcheons with patent or cylinder hole.	OTTONE LUCIDO VERNICIATO "OLV" OTTONE NATURALE "OL"	1 1	
670	Gancio fermapersiane. Shutter stop.	inc. mm 60 OTT. NATURALE "OL" inc. mm 80 OTT. NATURALE "OL" inc. mm 100 OTT. NATURALE "OL" inc. mm 120 OTT. NATURALE "OL" inc. mm 140 OTT. NATURALE "OL"	24 24 24 12 12	OTTONE / BRASS 
		BRONZATO +15% - CROMATO +25%		
800	Cricchetto sopra luce con incontro tipo A / tipo B. Finger catch.	OTTONE NATURALE "OL" CROMO LUCIDO "OCR" OTTONE BRONZATO "OB"	24 24 24	OTTONE / BRASS 
810	Pinza fermaporta con incontro tipo A / tipo B. Door stop keeper.	OTTONE NATURALE "OL" CROMO LUCIDO "OCR" OTTONE BRONZATO "OB"	24 24 24	OTTONE / BRASS 
460	Chiocciola fermaporta. Door stopper.	OTTONE LUCIDO VERNICIATO "OLV" CROMO LUCIDO "OCR" CROMO SATINATO "CRS" BRONZO GRAFFIATO LUCIDO "OBG" NIKEL SATINATO "NKS"	12* 12* 12* 12* 12*	ZAMA / ZAMAK 
461	Fermaporta a cilindro 36x28 mm. Door stopper.	OTTONE LUCIDO VERNICIATO "OLV" CROMO LUCIDO "OCR" CROMO SATINATO "CRS" BRONZO GRAFFIATO LUCIDO "OBG" NIKEL SATINATO "NKS"	12* 12* 12* 12* 12*	ZAMA / ZAMAK 
		* quantità minima tassativa		

ACCESSORI

CODICE	DESCRIZIONE	IMBALLO
--------	-------------	---------

MECCANISMI DRY KEEP PER FINESTRE ANTA RIBALTA

MOV/DK/1	Movimento DK 7x42 mm in metallo - 4 scatti	20
MOV/DK/4	Movimento DK 7x50 mm in metallo - 4 o 8 scatti	20
MOV/DK/3	Movimento DK in plastica - 4 scatti	20

**ALTRI ACCESSORI PER MONTAGGIO**

XQUADRO	Quadro ad espansione 8x65 mm	10
XQUADRO/80	Quadro ad espansione 8x80 mm	10
Q8/1	Quadrello da 8x105 mm standard	20
Q8/150	Quadrello da 8x150 mm	20
Q7/1	Quadrello da 7x105 mm	20
Q6/1	Quadrello da 6x105 mm	20
Q8/CAMBIO/130	Quadro 8 snodato 130 mm + 30 mm	4
NIPLES/90	Quadro 8x90 mm + Filetto M14	4
NIPLES/120	Quadro 8x120 mm + Filetto M14	4
NIPLES/130	Quadro 8x130 mm + Filetto M14	4
NIPLES/90/M10	Quadro 8x90 mm + Filetto M10	4
NIPLES/120/M10	Quadro 8x120 mm + Filetto M10	4



DUMMY/Q8	Piastrina di fissaggio con quadro 8	15
DUMMY/M10	Piastrina di fissaggio con Filetto M8	15

ACCESSORI

ACCESSORIES

CODICE/DESCIZIONE IMBALLO

**MECCANISMI "MOVIMENTI" PER MANIGLIE
DA FINESTRA SERIE LUSO
PER PLACCHE COPRIVATE**

MOV/GGB/1

Movimento Graz
con bussole

4



MOV/GGF/1

Movimento Graz
con fori

4



MOV/G7/1

Movimento Graz
con fori
+ Q7 "tre chiusure"

4



MOV/GGP/1

Movimento Graz
con perni

4



CODICE/DESCIZIONE IMBALLO

**MECCANISMI "MOVIMENTI" PER MANIGLIE
DA FINESTRA SERIE ECONOMICA
PER PLACCHE CON FORI A VISTA**

MOV/GGB/3

Movimento Graz
con bussole

6



MOV/GGF/2

Movimento Graz
con fori

6



MOV/GG7/4

Movimento Graz
con fori
+ Q7 "tre chiusure"

6



MOV/GP/3

Movimento Graz
con perni

6



ACCESSORI

ACCESSORIES

INOX





AMBRA

INOX aisi 304

CODICE	DESCRIZIONE	FINITURE	IMBALLO
176	Guarnitura con molla di ritorno su rosette coprivite e bocchette ø 52 mm con foro patent o foro yale. Pair spring handles on roses and escutcheons with patent or cylinder hole.	INOX SATINATO	1
176/OV	Guarnitura con molla di ritorno su rosette ovali coprivite e bocchette con foro patent o foro yale. Pair spring handles on oval roses and escutcheons with patent or cylinder hole.	INOX SATINATO	1
176/DK	Maniglia per finestra con movimento DK. Window handle with DK mechanism.	INOX SATINATO	2

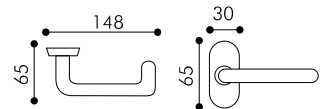
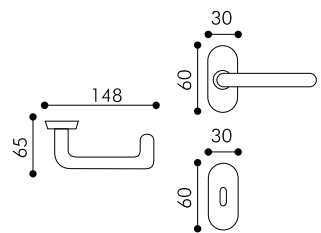
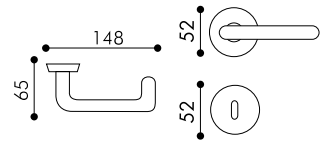

BIG LEVA

INOX aisi 304

CODICE	DESCRIZIONE	FINITURE	IMBALLO
136	Guarnitura con molla di ritorno su rosette coprivite e bocchette ø 52 mm con foro patent o foro yale. Pair spring handles on roses and escutcheons with patent or cylinder hole.	INOX SATINATO	1
136/OV	Guarnitura con molla di ritorno su rosette ovali coprivite e bocchette con foro patent o foro yale. Pair spring handles on oval roses and escutcheons with patent or cylinder hole.	INOX SATINATO	1

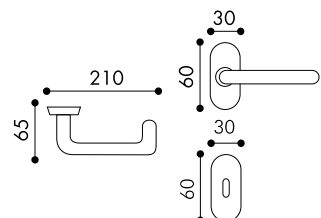
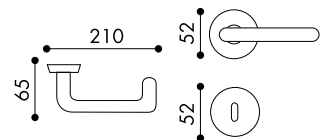

INOX aisi 304

CORNER

CODICE	DESCRIZIONE	FINITURE	IMBALLO
266	Guarnitura con molla di ritorno su rosette coprivite e bocchette \varnothing 52 mm con foro patent o foro yale. Pair spring handles on roses and escutcheons with patent or cylinder hole.	INOX SATINATO	1
266/OV	Guarnitura con molla di ritorno su rosette ovali coprivite e bocchette con foro patent o foro yale. Pair spring handles on oval roses and escutcheons with patent or cylinder hole.	INOX SATINATO	1
266/DK	Maniglia per finestra con movimento DK. Window handle with DK mechanism.	INOX SATINATO	2

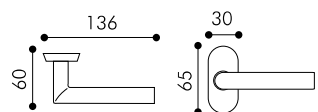
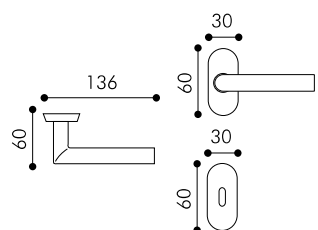
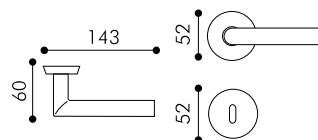

INOX aisi 304

APUS

CODICE	DESCRIZIONE	FINITURE	IMBALLO
166	Guarnitura con molla di ritorno su rosette coprivite e bocchette \varnothing 50 mm con foro patent o foro yale. Pair spring handles on roses and escutcheons with patent or cylinder hole.	INOX BICOLOR	1
166/OV	Guarnitura con molla di ritorno su rosette ovali coprivite e bocchette con foro patent o foro yale. Pair spring handles on oval roses and escutcheons with patent or cylinder hole.	INOX BICOLOR	1
166/DK	Maniglia per finestra con movimento DK. Window handle with DK mechanism.	INOX BICOLOR	2

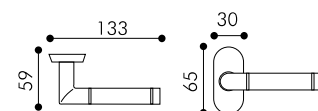
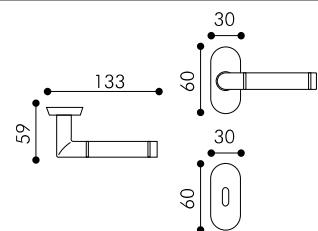
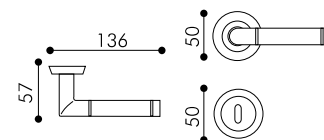



GIRO

INOX aisi 304

CODICE	DESCRIZIONE	FINITURE	IMBALLO
146	<p>Guarnitura con molla di ritorno su rosette coprivite e bocchette ø 52 mm con foro patent o foro yale.</p> <p>Pair spring handles on roses and escutcheons with patent or cylinder hole.</p>	INOX SATINATO	<p>1</p>
146/OV	<p>Guarnitura con molla di ritorno su rosette ovali coprivite e bocchette con foro patent o foro yale.</p> <p>Pair spring handles on oval roses and escutcheons with patent or cylinder hole.</p>	INOX SATINATO	<p>1</p>
146/DK	<p>Maniglia per finestra con movimento DK.</p> <p>Window handle with DK mechanism.</p>	INOX SATINATO	<p>2</p>



ORION

INOX aisi 304

CODICE	DESCRIZIONE	FINITURE	IMBALLO
206	<p>Guarnitura con molla di ritorno con impugnatura ridotta su rosetta coprivite h7 e bocchette con foro patent o foro yale</p> <p>Pair spring reduced handles on roses h7 and escutcheons ø50 with patent or cylinder hole</p>	INOX SATINATO	<p>1</p>
206/DK	<p>Maniglie per finestra con movimento DK con impugnatura ridotta</p> <p>Window reduced handles with DK mechanism</p>	INOX SATINATO	<p>1</p>

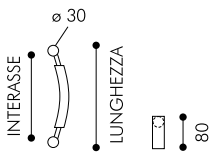
CODICE	DESCRIZIONE	FINITURE	IMBALLO										
MAN/011	<p>Maniglione zancato ø 30 mm senza rosette con kit di fissaggio.</p> <p>Pull handle decentralized round ø 30 mm without roses fixing system included.</p> 	<table border="1"> <thead> <tr> <th>Lunghezza</th> <th>Interasse</th> </tr> </thead> <tbody> <tr> <td>432</td> <td>400</td> </tr> <tr> <td>532</td> <td>500</td> </tr> </tbody> </table>	Lunghezza	Interasse	432	400	532	500	<table border="1"> <tbody> <tr> <td>INOX BICOLOR</td> <td>1</td> </tr> <tr> <td>INOX BICOLOR</td> <td>1</td> </tr> </tbody> </table>	INOX BICOLOR	1	INOX BICOLOR	1
Lunghezza	Interasse												
432	400												
532	500												
INOX BICOLOR	1												
INOX BICOLOR	1												



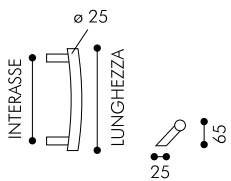

MAN/017	<p>Maniglione zancato ø 25 mm senza rosette con kit di fissaggio.</p> <p>Pull handle decentralized round ø 25 mm without roses fixing system included.</p> 	<table border="1"> <thead> <tr> <th>Lunghezza</th> <th>Interasse</th> </tr> </thead> <tbody> <tr> <td>450</td> <td>350</td> </tr> </tbody> </table>	Lunghezza	Interasse	450	350	<table border="1"> <tbody> <tr> <td>INOX BICOLOR</td> <td>1</td> </tr> </tbody> </table>	INOX BICOLOR	1
Lunghezza	Interasse								
450	350								
INOX BICOLOR	1								



MAN/001	<p>Maniglione diritto ø 32 mm senza rosette con kit di fissaggio.</p> <p>Pull handle straight round ø 32 mm without roses fixing system included.</p> 	<table border="1"> <thead> <tr> <th>Lunghezza</th> <th>Interasse</th> </tr> </thead> <tbody> <tr> <td>382</td> <td>350</td> </tr> </tbody> </table>	Lunghezza	Interasse	382	350	<table border="1"> <tbody> <tr> <td>INOX SATINATO</td> <td>1</td> </tr> </tbody> </table>	INOX SATINATO	1
Lunghezza	Interasse								
382	350								
INOX SATINATO	1								

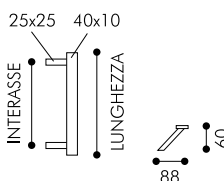

CODICE	DESCRIZIONE	FINITURE	IMBALLO												
MAN/014	<p>Maniglione zancato con frontale 40x10 mm senza rosette con kit di fissaggio.</p> <p>Pull handle decentralized 40x10 mm without roses fixing system included.</p>														
		<table border="1"> <thead> <tr> <th>Lunghezza</th> <th>Interasse</th> <th>FINITURE</th> <th>IMBALLO</th> </tr> </thead> <tbody> <tr> <td>500</td> <td>300</td> <td>INOX SATINATO</td> <td>1</td> </tr> <tr> <td>800</td> <td>600</td> <td>INOX SATINATO</td> <td>1</td> </tr> </tbody> </table>	Lunghezza	Interasse	FINITURE	IMBALLO	500	300	INOX SATINATO	1	800	600	INOX SATINATO	1	
Lunghezza	Interasse	FINITURE	IMBALLO												
500	300	INOX SATINATO	1												
800	600	INOX SATINATO	1												

MAN/004	<p>Maniglione diritto con frontale 40X10 mm senza rosette con kit di fissaggio .</p> <p>Pull handle straight 40x10 mm without roses fixing system included.</p>														
		<table border="1"> <thead> <tr> <th>Lunghezza</th> <th>Interasse</th> <th>FINITURE</th> <th>IMBALLO</th> </tr> </thead> <tbody> <tr> <td>500</td> <td>300</td> <td>INOX SATINATO</td> <td>1</td> </tr> <tr> <td>800</td> <td>600</td> <td>INOX SATINATO</td> <td>1</td> </tr> </tbody> </table>	Lunghezza	Interasse	FINITURE	IMBALLO	500	300	INOX SATINATO	1	800	600	INOX SATINATO	1	
Lunghezza	Interasse	FINITURE	IMBALLO												
500	300	INOX SATINATO	1												
800	600	INOX SATINATO	1												

CODICE	DESCRIZIONE	FINITURE	IMBALLO
--------	-------------	----------	---------

MAN/018

Maniglione **zancato**
 ø 32 mm senza rosette
 con kit di fissaggio

Pull handle **decentralized**
 round ø 32 mm
 without roses
 fixing system included

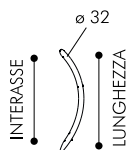

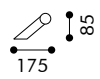
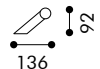
	Lunghezza	Interasse	FINITURE	IMBALLO
	575	500	INOX SATINATO	1
	780	700	INOX SATINATO	1



MAN/019

Maniglione **zancato**
 ø 32 mm senza rosette
 con kit di fissaggio

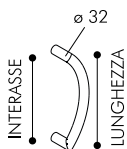

Pull handle **decentralized**
 round ø 32 mm
 without roses
 fixing system included





	Lunghezza	Interasse	FINITURE	IMBALLO
	382	350	INOX SATINATO	1

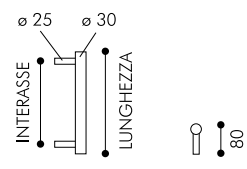

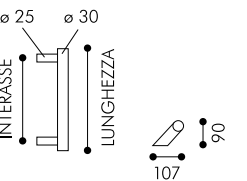

CODICE	DESCRIZIONE	FINITURE	IMBALLO
MAN/006B	Maniglione diritto tondo ø 30 mm senza rosette con kit di fissaggio		
	Pull handle straight round ø 30 mm without roses fixing system included	Lunghezza Interasse	
		300 210	INOX SATINATO 1
		500 300	INOX SATINATO 1
		700 500	INOX SATINATO 1
		1200 900	INOX SATINATO 1

MAN/006A	Maniglione zancato tondo ø 30 mm senza rosette con kit di fissaggio		
	Pull handle decentralized round ø 30 mm without roses fixing system included	Lunghezza Interasse	
		300 210	INOX SATINATO 1
		500 300	INOX SATINATO 1
		800 600	INOX SATINATO 1
		1200 900	INOX SATINATO 1

MAN/006SB	Maniglione diritto quadro 25x25 mm senza rosette con kit di fissaggio		
	Pull handle straight square 25x25 mm without roses fixing system included	Lunghezza Interasse	
		300 210	INOX SATINATO 1
		500 300	INOX SATINATO 1
		700 500	INOX SATINATO 1
		1200 1000	INOX SATINATO 1

MAN/006SA	Maniglione zancato quadro 25x25 mm senza rosette con kit di fissaggio		
	Pull handle decentralized square 25x25 mm without roses fixing system included	Lunghezza Interasse	
		500 300	INOX SATINATO 1
		800 600	INOX SATINATO 1
		1200 1000	INOX SATINATO 1

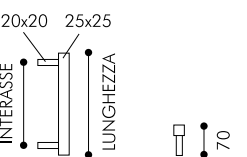

MANIGLIONI INOX aisi 316

PULL HANDLES

Linea Atelier

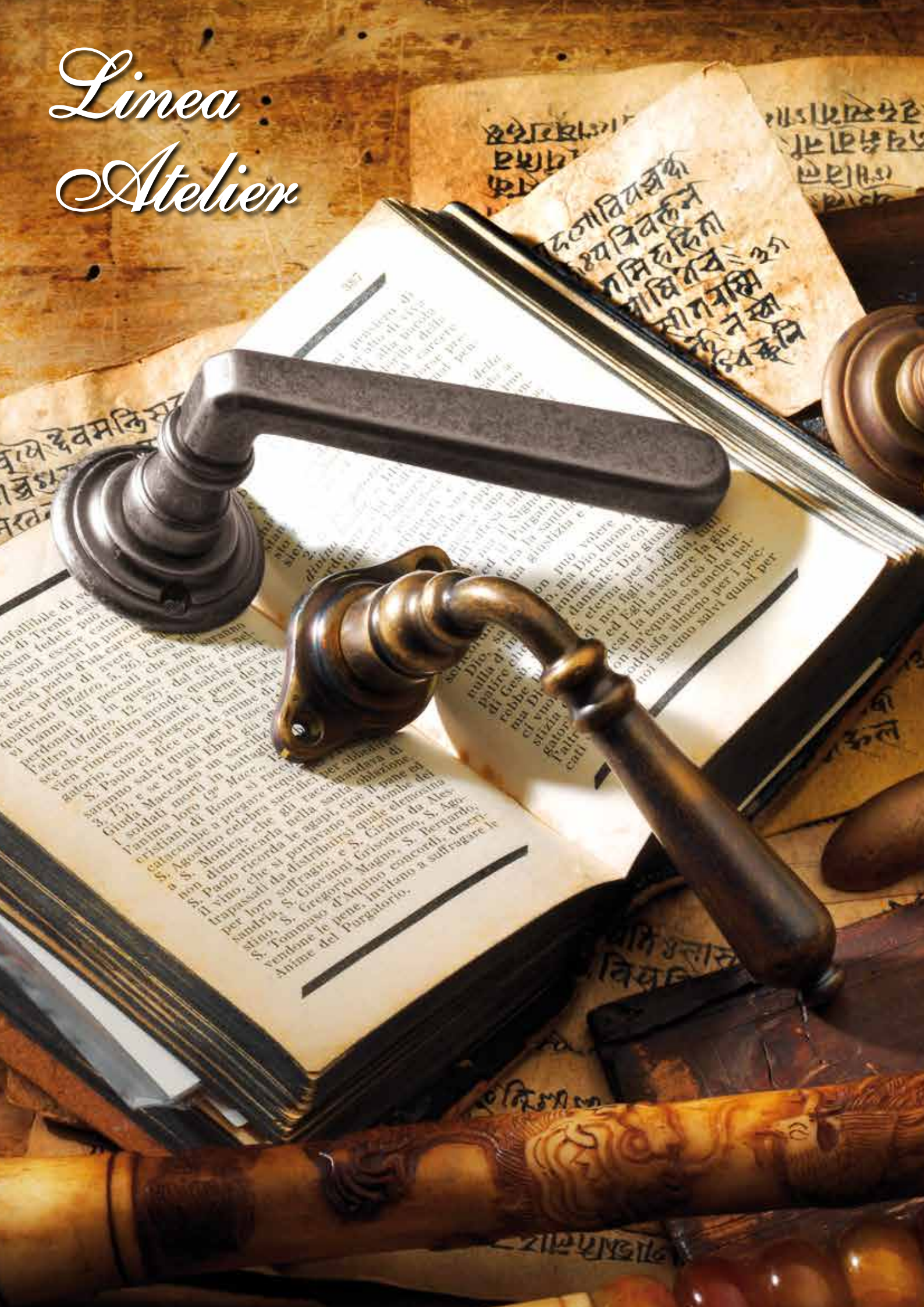





Ottone lucido naturale **OLN**



Ottone lucido verniciato **OLV**



Ottone invecchiato protetto **OIP**



Ottone opaco **OVI**



Ottone ferroantico **NA**



Ottone ad effetto ruggine **ORG**



Ottone gradualmente modificato **OGM**
(FINITURA SOLO A RICHIESTA)

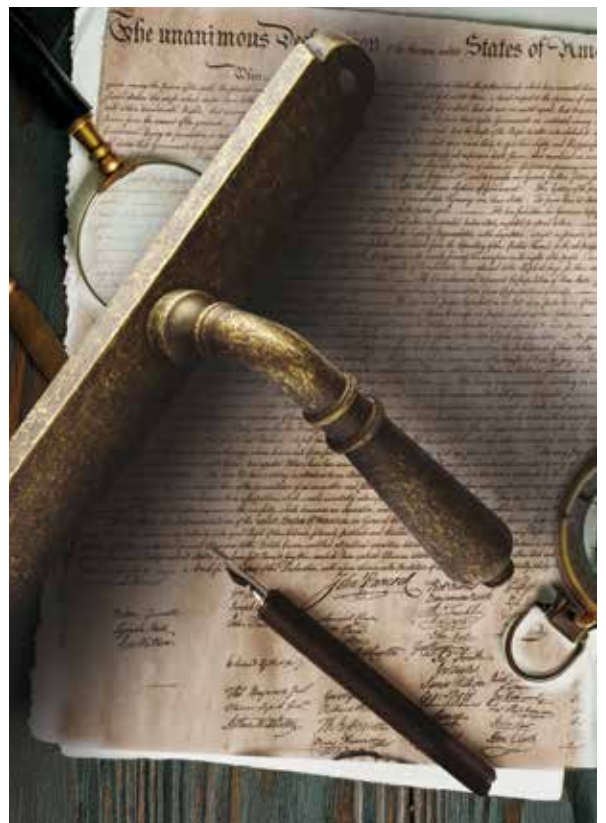

Ottone bronzato antico **OBA**

Stile

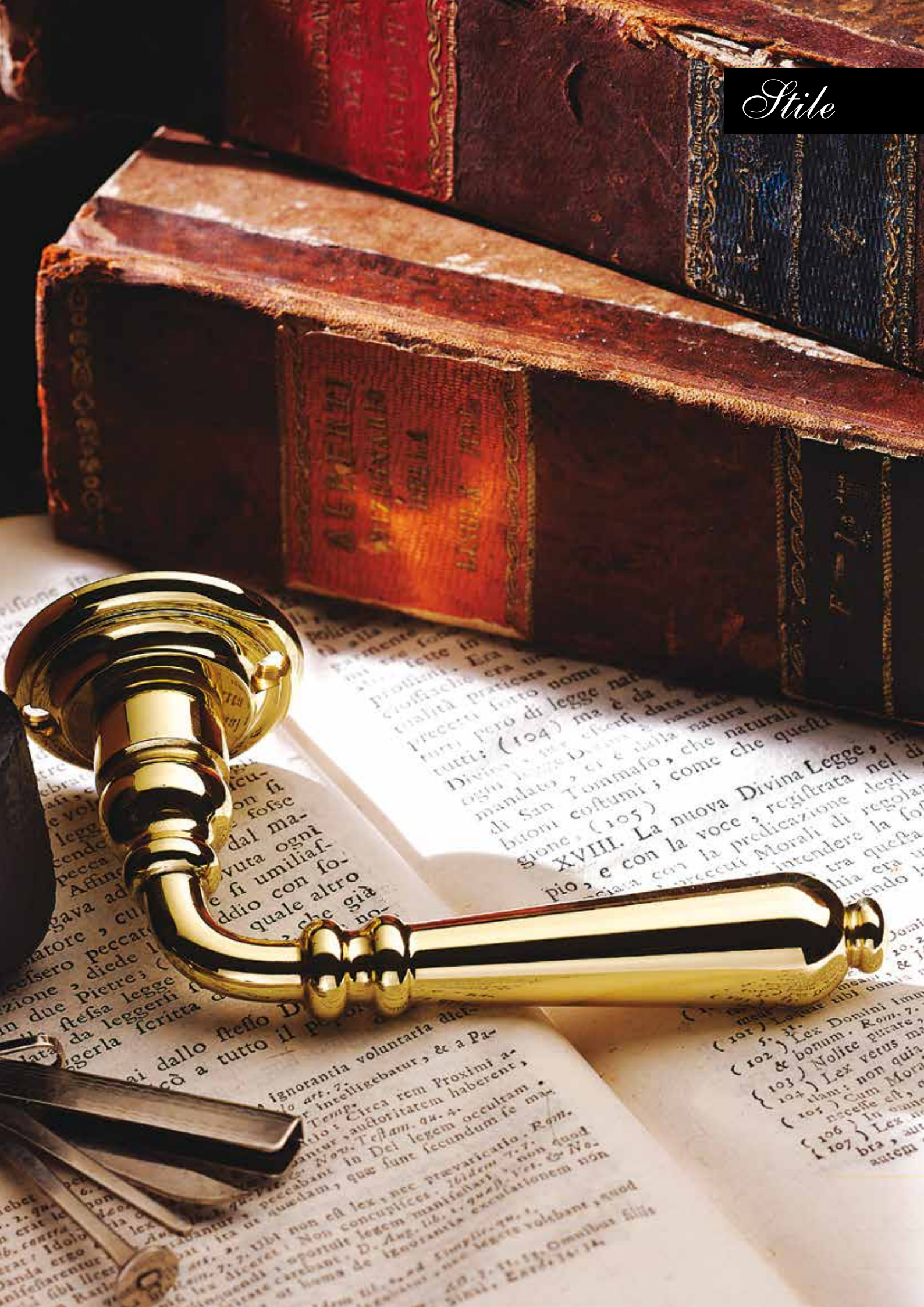

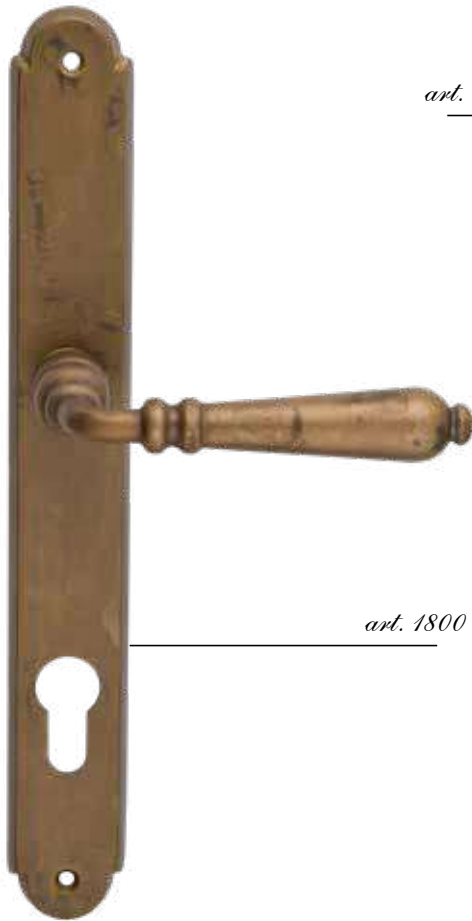

art. 1802



art. 1803



art. 1800

art. 1801



CODICE	DESCRIZIONE	FINITURE	IMBALLO
1800	Guarnitura su placca	OTTONE LUCIDO VERNICIATO "OLV" 1 OTTONE LUCIDO NON VERNICIATO "OLN" 1 OTTONE NATURALE OPACO "OVI" 1 OTTONE INVECCHIATO PROTETTO "OIP" 1 NIKEL NERO FERROANTICO "NA" 1	
1801	Guarnitura su rosetta	OTTONE LUCIDO VERNICIATO "OLV" 1 OTTONE LUCIDO NON VERNICIATO "OLN" 1 OTTONE NATURALE OPACO "OVI" 1 OTTONE INVECCHIATO PROTETTO "OIP" 1 NIKEL NERO FERROANTICO "NA" 1	
1802	Maniglia per finestra anta ribalta - DK	OTTONE LUCIDO VERNICIATO "OLV" 2 OTTONE LUCIDO NON VERNICIATO "OLN" 2 OTTONE NATURALE OPACO "OVI" 2 OTTONE INVECCHIATO PROTETTO "OIP" 2 NIKEL NERO FERROANTICO "NA" 2	
1803	Cremonese per finestra	OTTONE LUCIDO VERNICIATO "OLV" 1 OTTONE LUCIDO NON VERNICIATO "OLN" 1 OTTONE NATURALE OPACO "OVI" 1 OTTONE INVECCHIATO PROTETTO "OIP" 1 NIKEL NERO FERROANTICO "NA" 1	



Toscana





art. 1452



art. 1453



art. 1450

art. 1451



CODICE	DESCRIZIONE	FINITURE	IMBALLO
1450	Guarnitura su placca	OTTONE LUCIDO VERNICIATO "OLV" OTTONE LUCIDO NON VERNICIATO "OLN" OTTONE NATURALE OPACO "OVI" OTTONE INVECCHIATO PROTETTO "OIP"	1 1 1 1
1451	Guarnitura su rosetta	OTTONE LUCIDO VERNICIATO "OLV" OTTONE LUCIDO NON VERNICIATO "OLN" OTTONE NATURALE OPACO "OVI" OTTONE INVECCHIATO PROTETTO "OIP"	1 1 1 1
1452	Maniglia per finestra anta ribalta - DK	OTTONE LUCIDO VERNICIATO "OLV" OTTONE LUCIDO NON VERNICIATO "OLN" OTTONE NATURALE OPACO "OVI" OTTONE INVECCHIATO PROTETTO "OIP"	2 2 2 2
1453	Cremonese per finestra	OTTONE LUCIDO VERNICIATO "OLV" OTTONE LUCIDO NON VERNICIATO "OLN" OTTONE NATURALE OPACO "OVI" OTTONE INVECCHIATO PROTETTO "OIP"	2 2 2 2



Regina



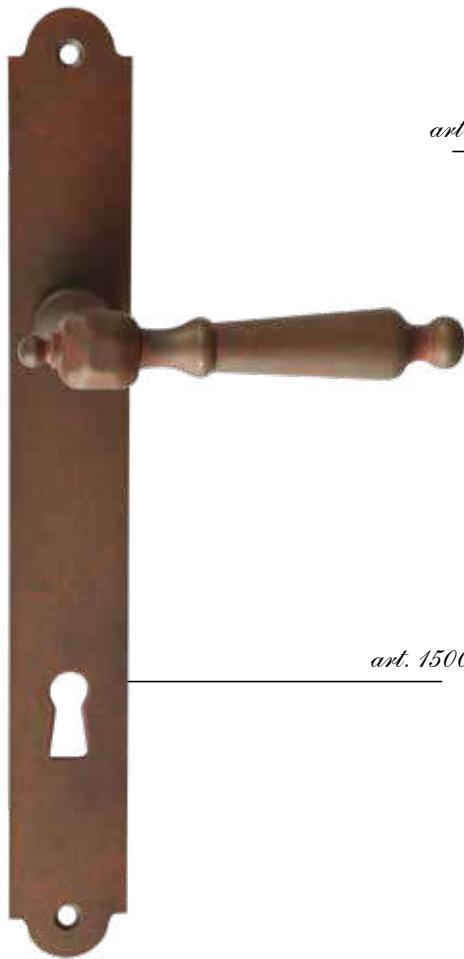

art.1502



art. 1504



art. 1500

art. 1501



CODICE	DESCRIZIONE	FINITURE	IMBALLO
1500	Guarnitura su placca	OTTONE LUCIDO VERNICIATO "OLV" OTTONE LUCIDO NON VERNICIATO "OLN" OTTONE INVECCHIATO PROTETTO "OIP" NIKEL NERO FERROANTICO "NA" EFFETTO RUGGINE "ORG"	1 1 1 1 1 
1501	Guarnitura su rosetta	OTTONE LUCIDO VERNICIATO "OLV" OTTONE LUCIDO NON VERNICIATO "OLN" OTTONE INVECCHIATO PROTETTO "OIP" NIKEL NERO FERROANTICO "NA" EFFETTO RUGGINE "ORG"	1 1 1 1 1 
1502	Maniglia per finestra anta ribalta - DK	OTTONE LUCIDO VERNICIATO "OLV" OTTONE LUCIDO NON VERNICIATO "OLN" OTTONE INVECCHIATO PROTETTO "OIP" NIKEL NERO FERROANTICO "NA" EFFETTO RUGGINE "ORG"	2 2 2 2 2 
1504	Cremonese per finestra ad impugnatura maniglia	OTTONE LUCIDO VERNICIATO "OLV" OTTONE LUCIDO NON VERNICIATO "OLN" OTTONE INVECCHIATO PROTETTO "OIP" NIKEL NERO FERROANTICO "NA" EFFETTO RUGGINE "ORG"	1 1 1 1 1 



Regina

Antiqua



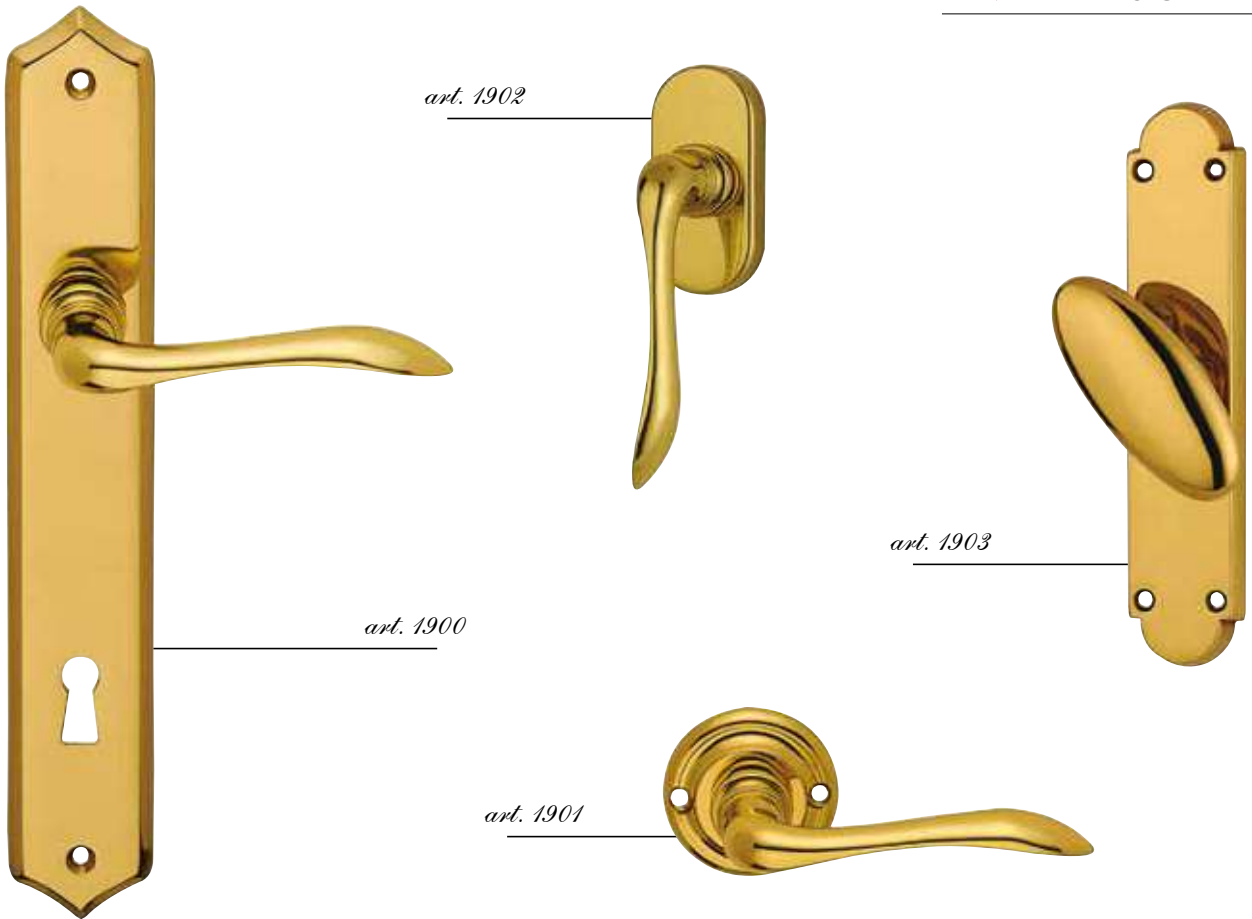

CODICE	DESCRIZIONE	FINITURE	IMBALLO
1900	Guarnitura su placca	OTTONE LUCIDO VERNICIATO "OLV" OTTONE LUCIDO NON VERNICIATO "OLN" OTTONE INVECCHIATO PROTETTO "OIP" OTTONE BRONZATO ANTICO "OBA"	1 1 1 1
1901	Guarnitura su rosetta	OTTONE LUCIDO VERNICIATO "OLV" OTTONE LUCIDO NON VERNICIATO "OLN" OTTONE INVECCHIATO PROTETTO "OIP" OTTONE BRONZATO ANTICO "OBA"	1 1 1 1
1902	Maniglia per finestra anta ribalta - DK	OTTONE LUCIDO VERNICIATO "OLV" OTTONE LUCIDO NON VERNICIATO "OLN" OTTONE INVECCHIATO PROTETTO "OIP" OTTONE BRONZATO ANTICO "OBA"	2 2 2 2
1903	Cremonese per finestra	OTTONE LUCIDO VERNICIATO "OLV" OTTONE LUCIDO NON VERNICIATO "OLN" OTTONE INVECCHIATO PROTETTO "OIP" OTTONE BRONZATO ANTICO "OBA"	1 1 1 1



Rustica



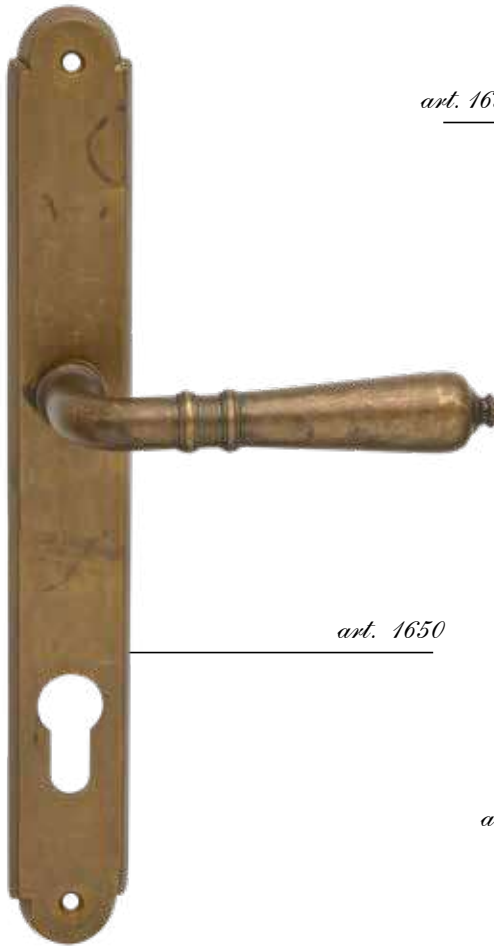

art. 1650



art. 1652



art. 1653



art. 1651

CODICE	DESCRIZIONE	FINITURE	IMBALLO	
1650	Guarnitura su placca	OTTONE LUCIDO VERNICIATO "OLV" OTTONE LUCIDO NON VERNICIATO "OLN" OTTONE NATURALE OPACO "OVI" OTTONE INVECCHIATO PROTETTO "OIP" OTTONE BRONZATO ANTICO "OBA"	1 1 1 1 1	
1651	Guarnitura su rosetta	OTTONE LUCIDO VERNICIATO "OLV" OTTONE LUCIDO NON VERNICIATO "OLN" OTTONE NATURALE OPACO "OVI" OTTONE INVECCHIATO PROTETTO "OIP" OTTONE BRONZATO ANTICO "OBA"	1 1 1 1 1	
1652	Maniglia per finestra anta ribalta - DK	OTTONE LUCIDO VERNICIATO "OLV" OTTONE LUCIDO NON VERNICIATO "OLN" OTTONE NATURALE OPACO "OVI" OTTONE INVECCHIATO PROTETTO "OIP" OTTONE BRONZATO ANTICO "OBA"	2 2 2 2 2	
1653	Cremonese per finestra	OTTONE LUCIDO VERNICIATO "OLV" OTTONE LUCIDO NON VERNICIATO "OLN" OTTONE NATURALE OPACO "OVI" OTTONE INVECCHIATO PROTETTO "OIP" OTTONE BRONZATO ANTICO "OBA"	1 1 1 1 1	







CODICE	DESCRIZIONE	FINITURE	IMBALLO
1850	Guarnitura su placca	OTTONE LUCIDO VERNICIATO "OLV"	1
		OTTONE LUCIDO NON VERNICIATO "OLN"	1
		OTTONE INVECCHIATO PROTETTO "OIP"	1
		EFFETTO RUGGINE "ORG"	1
		OTTONE BRONZATO ANTICO "OBA"	1
1851	Guarnitura su rosetta	OTTONE LUCIDO VERNICIATO "OLV"	1
		OTTONE LUCIDO NON VERNICIATO "OLN"	1
		OTTONE INVECCHIATO PROTETTO "OIP"	1
		EFFETTO RUGGINE "ORG"	1
		OTTONE BRONZATO ANTICO "OBA"	1
1852	Maniglia per finestra anta ribalta - DK	OTTONE LUCIDO VERNICIATO "OLV"	2
		OTTONE LUCIDO NON VERNICIATO "OLN"	2
		OTTONE INVECCHIATO PROTETTO "OIP"	2
		EFFETTO RUGGINE "ORG"	2
		OTTONE BRONZATO ANTICO "OBA"	2
1853	Cremonese per finestra	OTTONE LUCIDO VERNICIATO "OLV"	1
		OTTONE LUCIDO NON VERNICIATO "OLN"	1
		OTTONE INVECCHIATO PROTETTO "OIP"	1
		EFFETTO RUGGINE "ORG"	1
		OTTONE BRONZATO ANTICO "OBA"	1

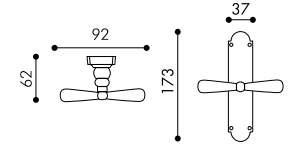
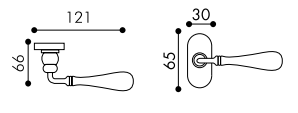
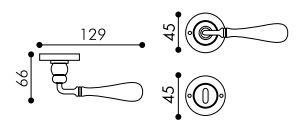
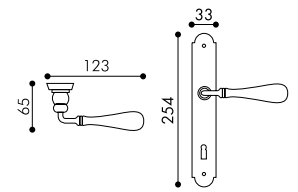

Pressburg





CODICE	DESCRIZIONE	FINITURE	IMBALLO
5070	Guarnitura su placca	OTTONE LUCIDO VERNICIATO "OLV" OTTONE LUCIDO NON VERNICIATO "OLN" OTTONE INVECCHIATO PROTETTO "OIP" NIKEL NERO FERROANTICO "NA" EFFETTO RUGGINE "ORG"	1 1 1 1 1
5071/f	Guarnitura su rosetta	OTTONE LUCIDO VERNICIATO "OLV" OTTONE LUCIDO NON VERNICIATO "OLN" OTTONE INVECCHIATO PROTETTO "OIP" NIKEL NERO FERROANTICO "NA" EFFETTO RUGGINE "ORG"	1 1 1 1 1
5072	Maniglia per finestra anta ribalta - DK	OTTONE LUCIDO VERNICIATO "OLV" OTTONE LUCIDO NON VERNICIATO "OLN" OTTONE INVECCHIATO PROTETTO "OIP" NIKEL NERO FERROANTICO "NA" EFFETTO RUGGINE "ORG"	2 2 2 2 2
5073	Cremonese per finestra	OTTONE LUCIDO VERNICIATO "OLV" OTTONE LUCIDO NON VERNICIATO "OLN" OTTONE INVECCHIATO PROTETTO "OIP" NIKEL NERO FERROANTICO "NA" EFFETTO RUGGINE "ORG"	1 1 1 1 1

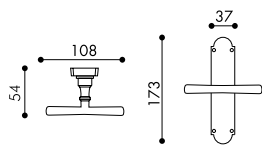
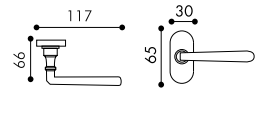
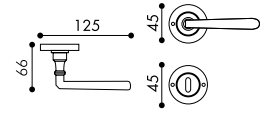
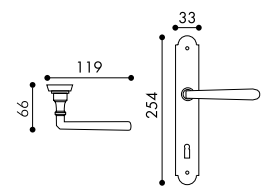

Luxor



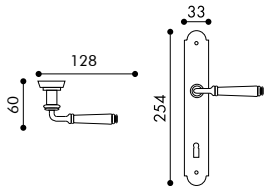
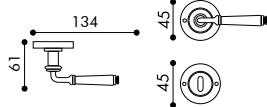
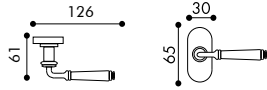
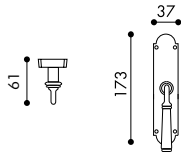

CODICE	DESCRIZIONE	FINITURE	IMBALLO
1280	Guarnitura su placca	OTTONE LUCIDO VERNICIATO "OLV" OTTONE LUCIDO NON VERNICIATO "OLN" OTTONE NATURALE OPACO "OVI" OTTONE INVECCHIATO PROTETTO "OIP" NIKEL NERO FERROANTICO "NA"	1 1 1 1 1 
1281	Guarnitura su rosetta	OTTONE LUCIDO VERNICIATO "OLV" OTTONE LUCIDO NON VERNICIATO "OLN" OTTONE NATURALE OPACO "OVI" OTTONE INVECCHIATO PROTETTO "OIP" NIKEL NERO FERROANTICO "NA"	1 1 1 1 1 
1282	Maniglia per finestra anta ribalta - DK	OTTONE LUCIDO VERNICIATO "OLV" OTTONE LUCIDO NON VERNICIATO "OLN" OTTONE NATURALE OPACO "OVI" OTTONE INVECCHIATO PROTETTO "OIP" NIKEL NERO FERROANTICO "NA"	2 2 2 2 2 
1284	Cremonese per finestra ad impugnatura maniglia	OTTONE LUCIDO VERNICIATO "OLV" OTTONE LUCIDO NON VERNICIATO "OLN" OTTONE NATURALE OPACO "OVI" OTTONE INVECCHIATO PROTETTO "OIP" NIKEL NERO FERROANTICO "NA"	1 1 1 1 1 



Maniglioni



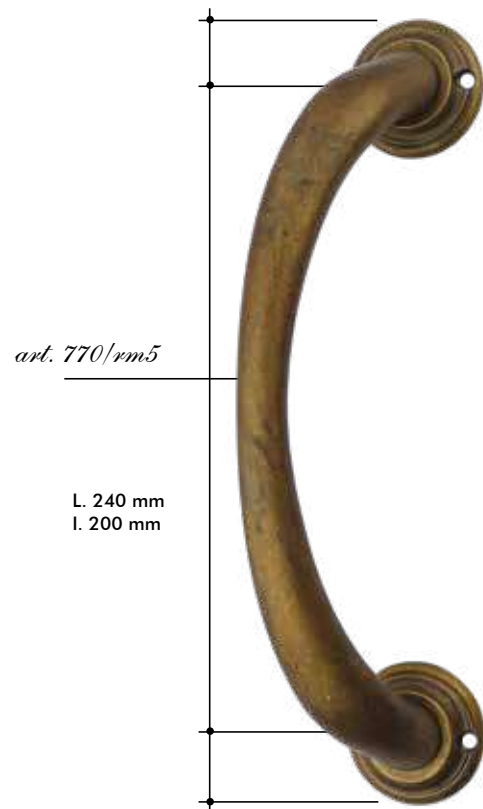
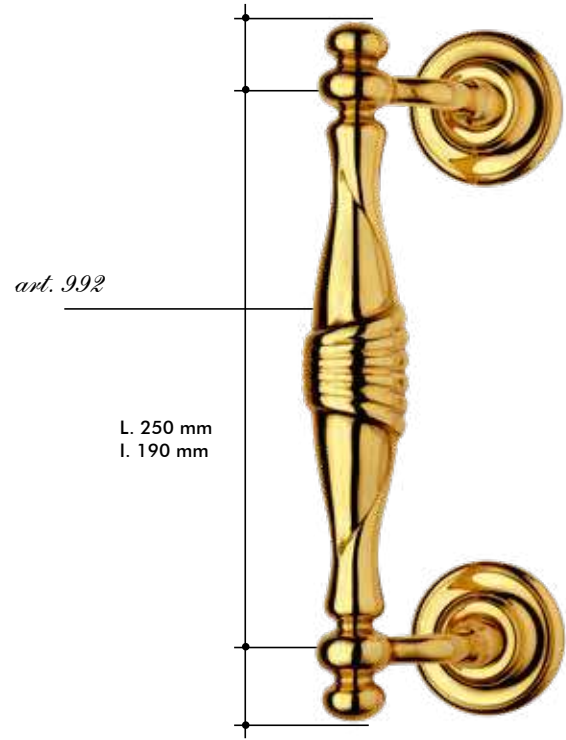
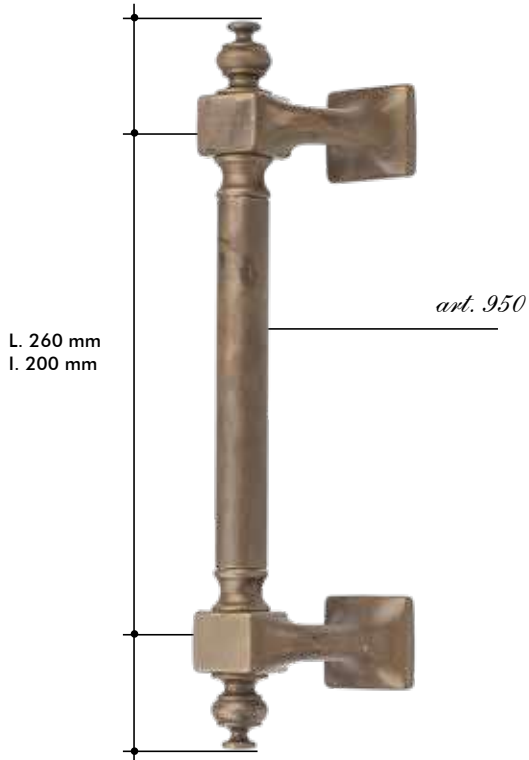

OLV



OLN



OVI



OIP



OBA



NA



ORG

*Pomoli Battenti
e Arzanti*



वता लन
ववददविलयुयागशवे
नीदुश ॥२२॥
२२ गमथगदा
२३ शक्तिस्व
२४ मातन
२५ गोदसव
२६ गोदसि
२७ गोदसि
२८ गोदसि
२९ गोदसि
३० गोदसि
३१ गोदसि
३२ गोदसि
३३ गोदसि
३४ गोदसि
३५ गोदसि
३६ गोदसि
३७ गोदसि
३८ गोदसि
३९ गोदसि
४० गोदसि



art. 127 ø 70



art. 128 ø 65

art. 522 ø 120



*art. 1840
alzante singolo*

*Disponibile versione a
coppia con foro yale
art. 1841*



OLV



OLN



OVI



OIP



OBA



NA



ORG

Kit Scorrevoli e Minuteria





*art. 95
con serratura*



art. 95/sf



*art. 94
con serratura*

Misure:

- 60 mm.
- 80 mm.
- 100 mm.
- 120 mm.
- 140 mm.



art. 670

Misure diametro interno:

- Ø 14 mm
- Ø 16 mm
- Ø 20 mm

*art. 21
Copricerniera*



art. 680

Misure:

- 5 mm.
- 10 mm.
- 15 mm.
- 20 mm.
- 25 mm.
- 30 mm.



*art. 1301
ovalino singolo
su rosetta, senza bocchetta*

Specificare se fisso o girevole



OLV



OLN



OVI



OIP



OBA



NA



ORG

Componenti Atelier

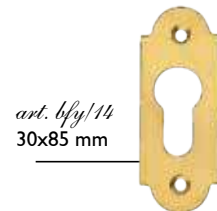
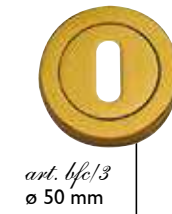
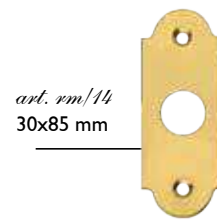
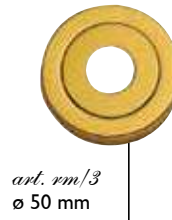
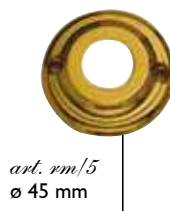
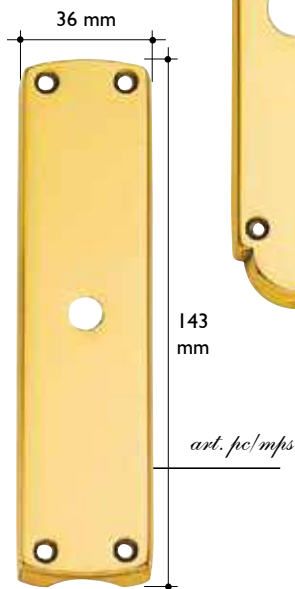
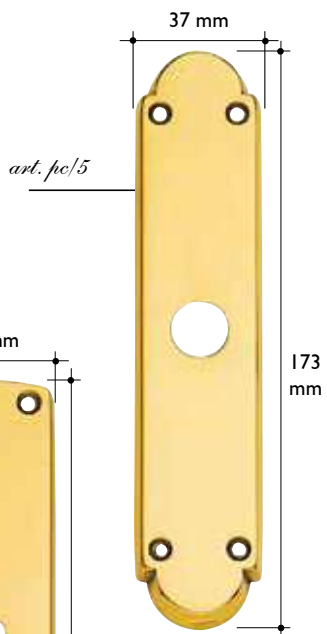
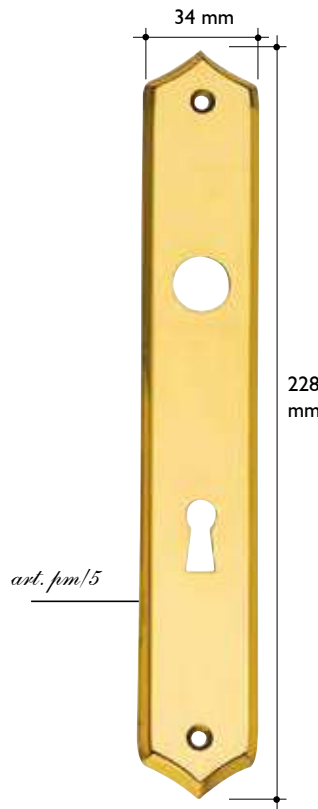
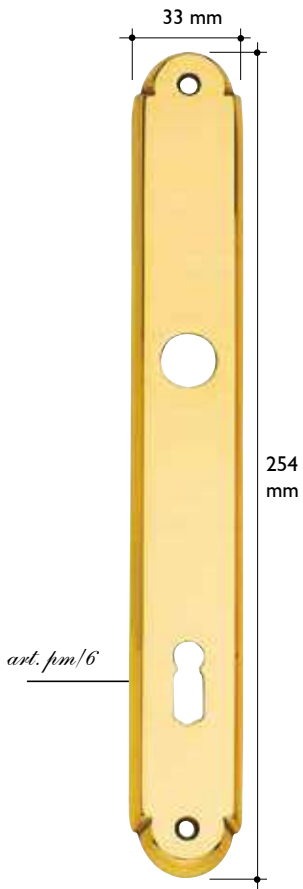

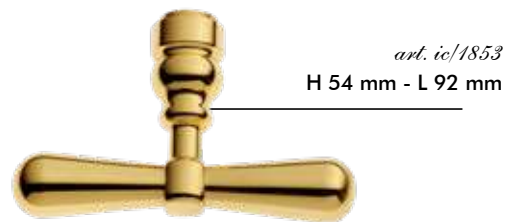
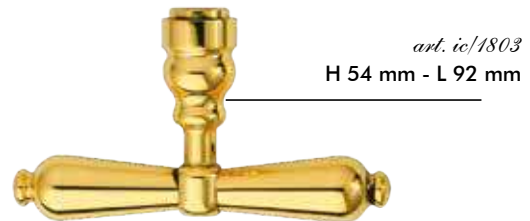
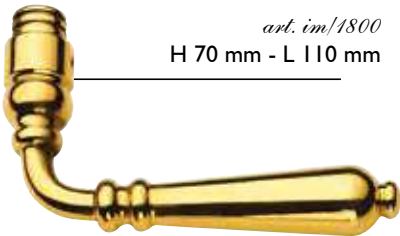
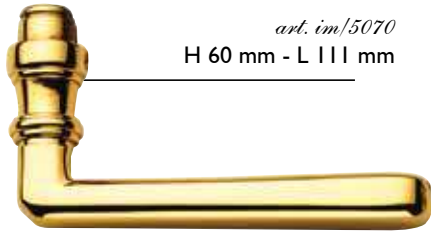
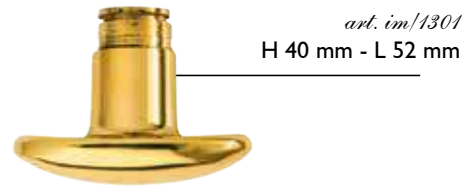
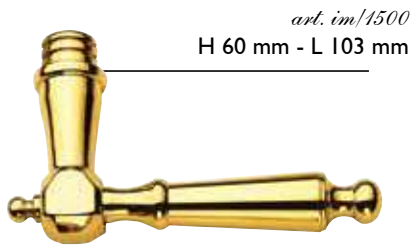

OLV



OLN



OVI



OIP



OBA



NA



ORG

CONDIZIONI GENERALI DI VENDITA

PREZZI:

Il prezzo di listino è riferito a N° 1 pezzo dell'articolo con codice ad esso riferito IVA esclusa con resa franco partenza.

SPEDIZIONI:

La merce viaggia in ogni caso a rischio e pericolo del committente. In assenza di precise istruzioni circa il mezzo di inoltro della merce le spedizioni sono eseguite nel modo ritenuto più idoneo ed economico senza nessuna responsabilità della Casa.

PAGAMENTI:

Devono essere effettuati direttamente al domicilio della nostra sede o mediante spedizione di nostre ricevute bancarie entro la scadenza concordata. Eventuali ritardi comportano il conteggio degli interessi di mora.

ORDINI:

Tutti gli ordini devono essere inoltrati ai nostri agenti di zona utilizzando codici e descrizioni corrette di quanto richiesto. Eventuali ordini inviati direttamente alla nostra sede sono accettati solo se trasmessi via email e complementi di codici e descrizioni corretti di quanto richiesto. Tutti gli ordini, in ogni caso, sono subordinati all'approvazione della Casa.

FATTURAZIONE:

Il minimo importo netto merce fatturabile è di € 150,00.

TERMINI DI CONSEGNA:

Il termine di consegna e di spedizione, anche se confermato, costituisce una semplice previsione ed ha perciò un valore indicativo, quindi non comporta nessuna garanzia e nessun indennizzo è dovuto per la mancata consegna nel termine previsto.

ARTICOLI E RICHIESTE FUORI CATALOGO:

Ogni variazione rispetto agli articoli a listino è da considerarsi prodotto speciale per il quale, di volta in volta, è necessario richiedere fattibilità, quantità minima, prezzo. La fornitura di prodotti speciali a richiesta è subordinata all'accettazione da parte del committente della relativa conferma d'ordine. La Casa si riserva il diritto di approvare modifiche agli articoli e variazione dei prezzi senza preavviso.

RESI:

Non si accettano resi di merce, se non espressamente autorizzati dalla Casa. Le contestazioni, devono essere fatte entro 8 giorni dal ricevimento della merce. Le richieste di reso devono pervenire via email, verranno analizzate ed eventualmente autorizzate mediante apposita "**Scheda di Autorizzazione Reso**" indicante tutte le modalità e condizioni alle quali verrà accettato il reso. Qualsiasi reso pervenuto senza preavviso ed autorizzazione verrà respinto al mittente. Per prodotti speciali approntati a richiesta non si accettano resi per alcun motivo.

Per qualsiasi controversia è competente il Foro di Brescia.

CAMPIONATURA:

Materiale pubblicitario gratuito con un primo ordine superiore a € 1.000,00.

AVVERTENZE IMPORTANTI

L'**OTTONE** e la **ZAMA** sono leghe soggette all'ossidazione, vulnerabili all'azione del tempo e dell'usura, in relazione ai diversi tipi di finiture e all'intensità di utilizzo.

SI RACCOMANDA DI:

EVITARE

di installare il prodotto in ambienti freschi di pittura (attendere l'essiccazione completa di qualsiasi tipo di tinteggiatura, su muro o su legno), e nelle vicinanze di parquet in legno appena posati e verniciati, pavimenti in marmo e granito appena levigati.

EVITARE NEL MODO PIÙ ASSOLUTO

L'uso di sostanze corrosive quali detersivi, pulivetro, sidol, abrasivi e altri prodotti simili lucidanti o sgrassanti contenenti acido fluoridrico o muriatico.

La scalfittura ad opera di oggetti contundenti quali chiavi, anelli, cacciaviti, viti e altri.

SPOLVERARE O PULIRE IL PRODOTTO CON UN PANNO MORBIDO DI LANA O SE NECESSARIO CON SPUGNA E SEMPLICE ACQUA TIEPIDA.

IMBALLO - PACKAGING:

MANIGLIA	QUANTITÀ PER CARTONE
rosetta imballo singolo	18/24
rosetta imballo doppio	24
placca	24
dk imballo a 2 pezzi	36
dk imballo a 4 pezzi	48







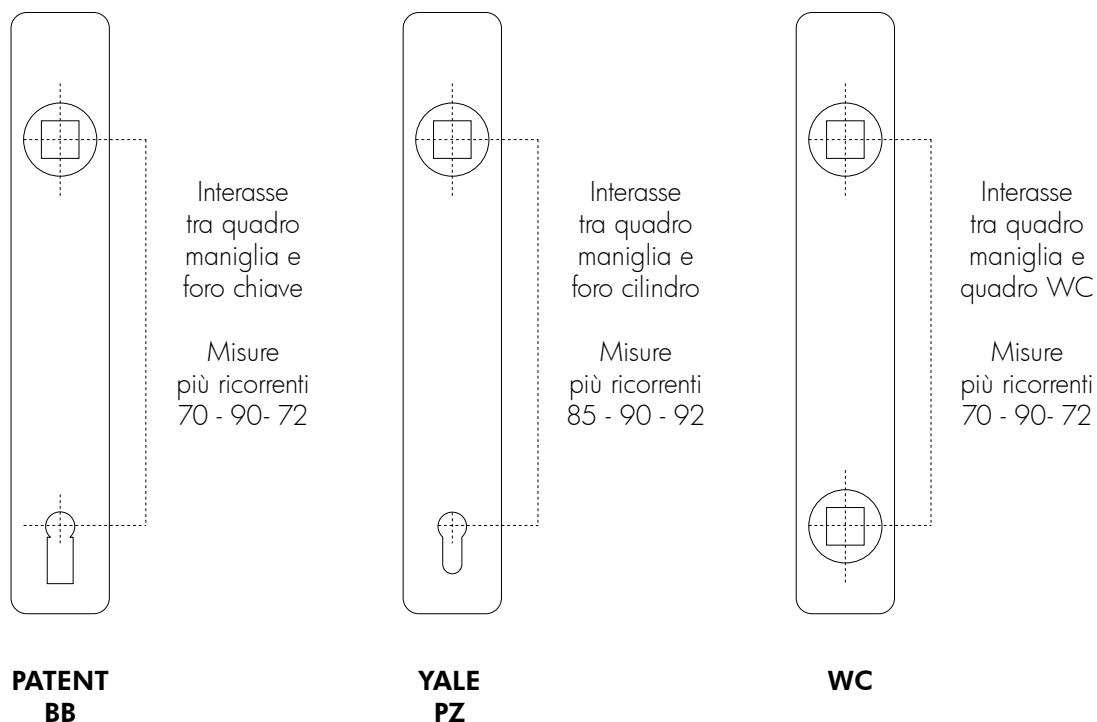

INDICAZIONI PER UNA CORRETTA STESURA DELLE COMMISSIONI

Per ogni ordinazione è necessario segnalare sulle commissioni i dati identificativi del modello desiderato, indicando il codice dell'articolo. È inoltre indispensabile precisare:

A) PER LE MANIGLIE SU PLACCA: il tipo di foro e la distanza (interasse) fra il foro maniglia e il foro chiave:



B) PER LE MANIGLIE DA FINESTRA: indicare se si richiede la guarnitura (senza meccanismo) che agisce esclusivamente in chiusura con il solo ferro Q.7 o LA GUARNITURA CON MECCANISMO, in questo caso è indispensabile specificare il tipo di meccanismo "gioco" da applicare:

	Gratz con fori		Gratz con fori $\varnothing 7$		MP per aste da incassare e ferro $\varnothing 7$
	Gratz con bussole		Gratz con bussole e ferro $\varnothing 7$		MP per aste da incassare
	Gratz con perni		Gratz con perni e ferro $\varnothing 7$		Gola lupo laterale

DENOMINAZIONE DEL VERSO "MANO" maniglie singole

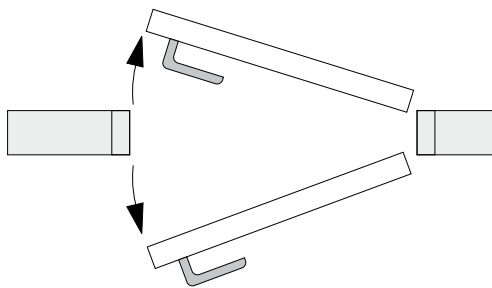
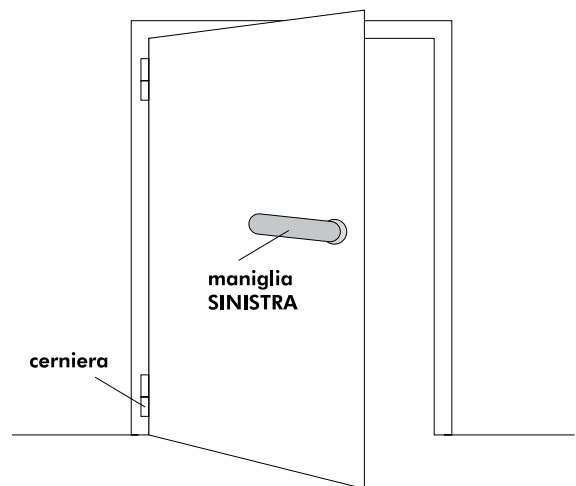
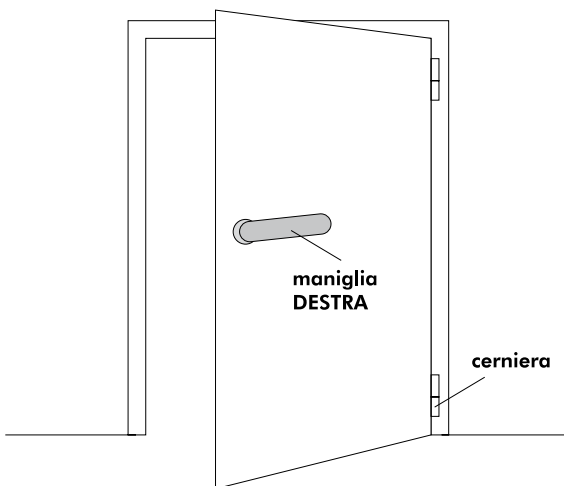

"mezza" maniglia DESTRA
sia per porte a tirare
che a spingere

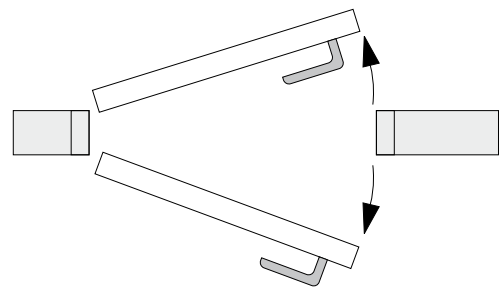

"mezza" maniglia SINISTRA
sia per porte a tirare
che a spingere



Grande attenzione al design, ricerca continua di soluzioni innovative, accuratezza delle finiture e massima qualità progettuale e costruttiva. Queste sono le caratteristiche imprescindibili delle proposte Arieni, realizzate internamente all'azienda per offrire prodotti totalmente made in Italy che garantiscono un perfetto connubio tra estetica e performance.

Le maniglie e accessori per porte e finestre di Arieni sono destinate sia ad abitazioni private sia a contesti residenziali come palazzine, residence e condomini, aziende e uffici, strutture ricettive e locali, e sono progettate e realizzate per soddisfare le più differenti esigenze tecniche, architettoniche e stilistiche. Il catalogo Arieni, infatti, è ampio ed eterogeneo, spazia dai modelli contemporanei a quelli classici, dalle linee vintage a quelle di design, per offrire a ogni cliente una scelta vasta e versatile. Siamo costantemente impegnati nella ricerca e sviluppo di soluzioni dal design originale ed esclusivo, con grande attenzione alla cura dei dettagli e alle finiture più resistenti e, allo stesso tempo, accattivanti.

Sin dalla sua fondazione, l'obiettivo di Arieni consiste nel raggiungere la totale soddisfazione dei clienti, grazie ad una proposta ampia, articolata e completa di prodotti di ottima qualità, ideati per durare nel tempo garantendo sempre ottime prestazioni.

Enormous attention paid to design, ongoing research for innovative solutions, precise finishes and maximum design and construction quality: these are the indispensable features of Arieni's line, made in-house to offer totally "Made in Italy" products that guarantee a perfect combination of beauty and performance.

Arieni door and window handles and accessories are designed for both private homes and residential contexts such as houses, service flats and apartment buildings, companies and offices, hotel facilities, eating and drinking establishments. They are designed and made to meet very diverse technical, architectural and stylistic needs. The Arieni catalogue is extensive and diversified. It ranges from contemporary to classic styles, from vintage to design lines to offer all customers a wide and versatile selection. We are constantly involved in research and development of original and exclusive design solutions and we pay enormous attention to details and the most hard-wearing and, at the same time, captivating, finishes.

Ever since it was established Arieni's goal has been to fully satisfy its customers with a wide, articulate and complete range of top quality products designed to last over time to constantly guarantee outstanding performance.



